

503017

III
45

OSZK

Országos Széchényi Könyvtár

Cséti

RAJZTÁBLÁK

Bányamérésről

és

Földmérésről

II.

45

OSZK

Országos Széchényi Könyvtár





RAJZTÁBLÁK

CSÉTI OTTÓ

BÁNYAMÉRÉSTAN ÉS FELSŐ FÖLDMÉRÉSTANÁHOZ.

≡ NEGYVENNÉGY LAP. ≡

1894.

OSZK

Országos Széchényi Könyvtár

503 917

~~254050~~

ORSZ. SZÉCHENYI-KÖNYVTÁR
N Növevénykönyvtár
1953 év 2867 SZ.

Ⓜ
2

1. ábra.

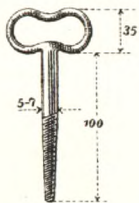

2. ábra.

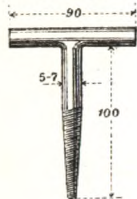

3. ábra.



4. ábra.

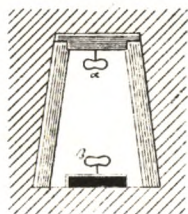

5. ábra.

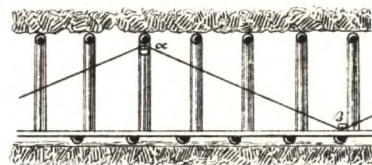

6. ábra.

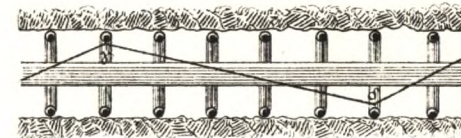

8. ábra.

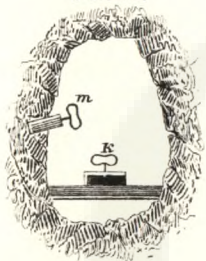

7. ábra.



9. ábra.

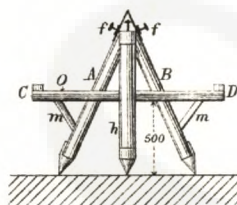

10. ábra.

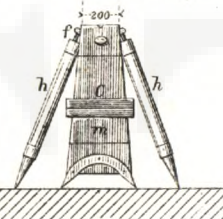

11. ábra.

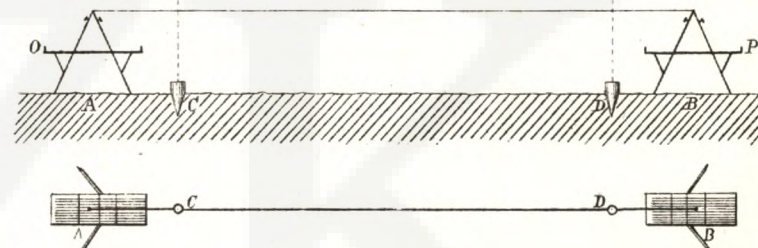

12. ábra.

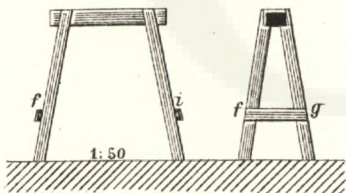

13. ábra.

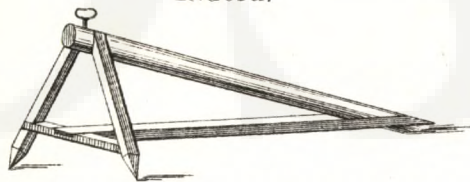

14. ábra.



15 B. ábra.



15. C. ábra.



16. ábra.

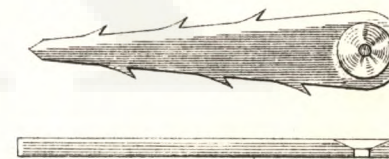

17. ábra.

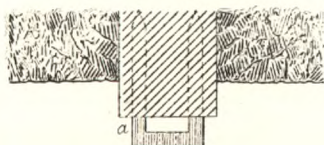

18. ábra.

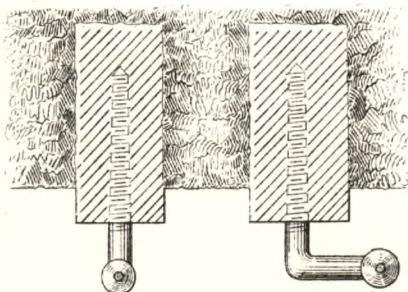

19. ábra.

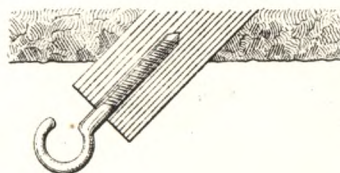

20. ábra.

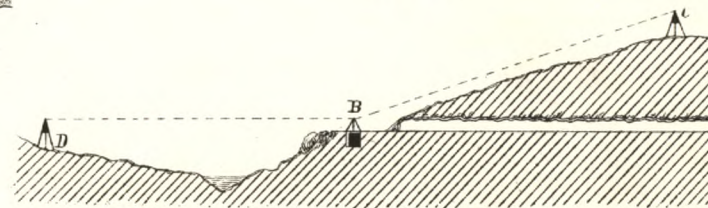

15 D. áb.

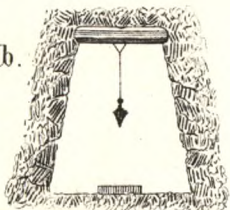

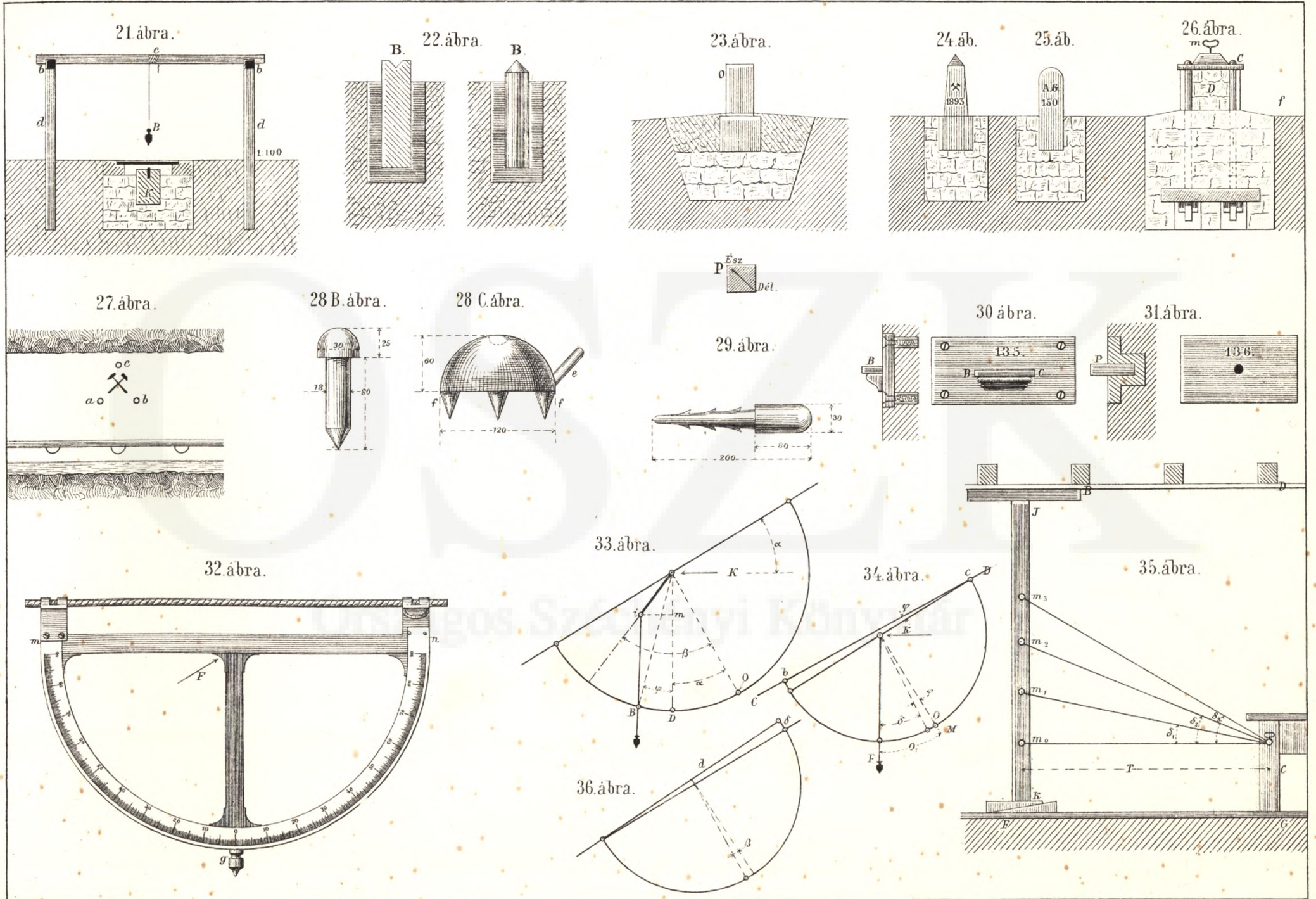

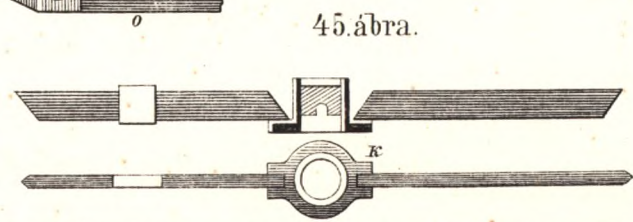
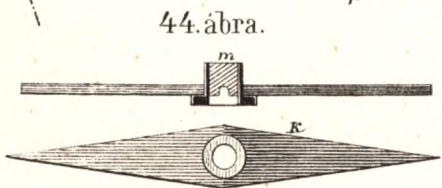
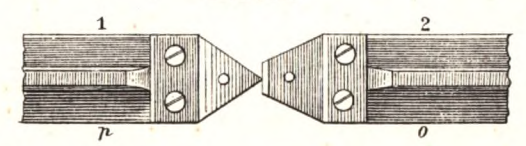
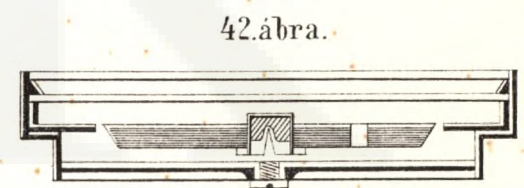
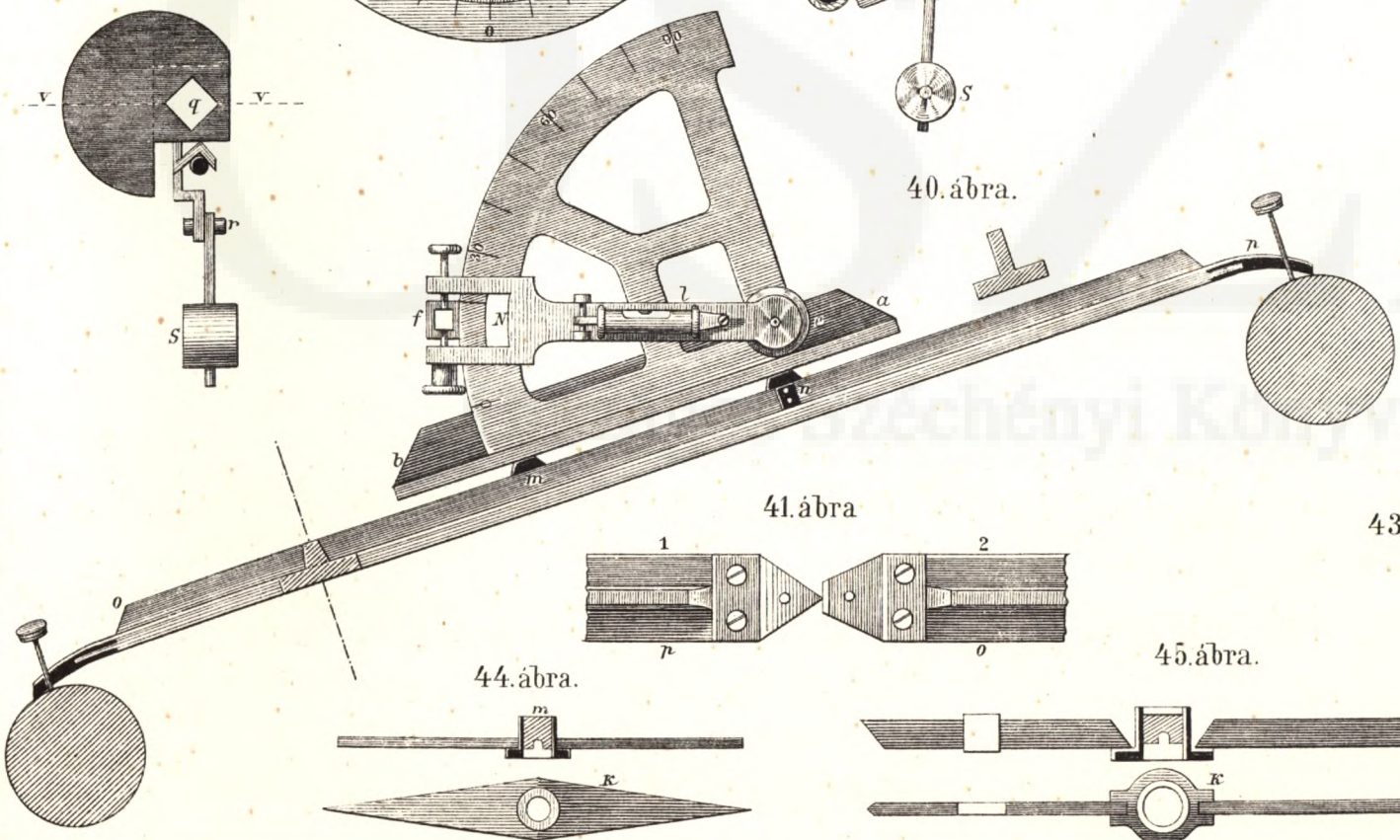
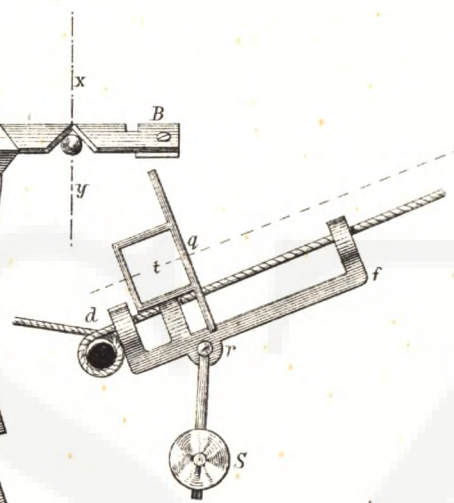
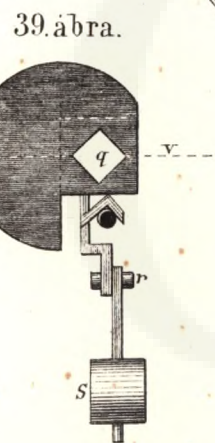
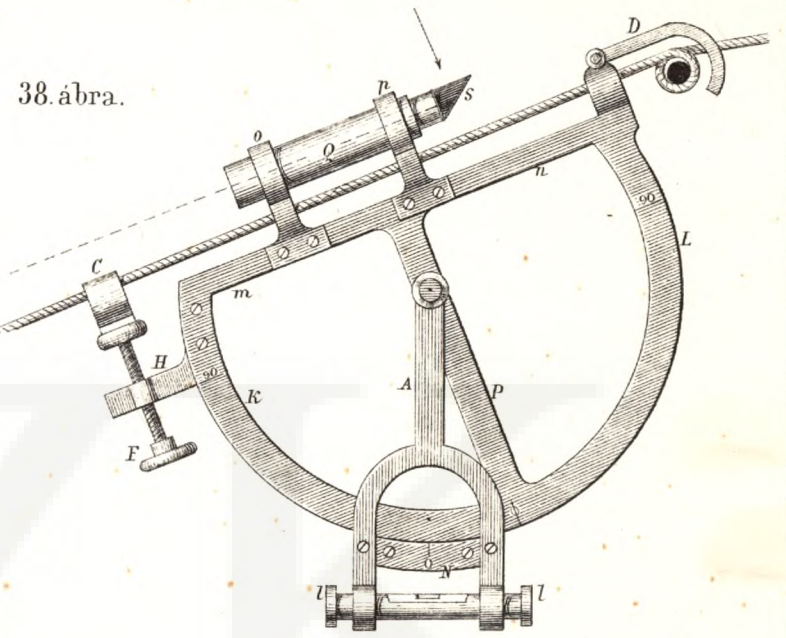
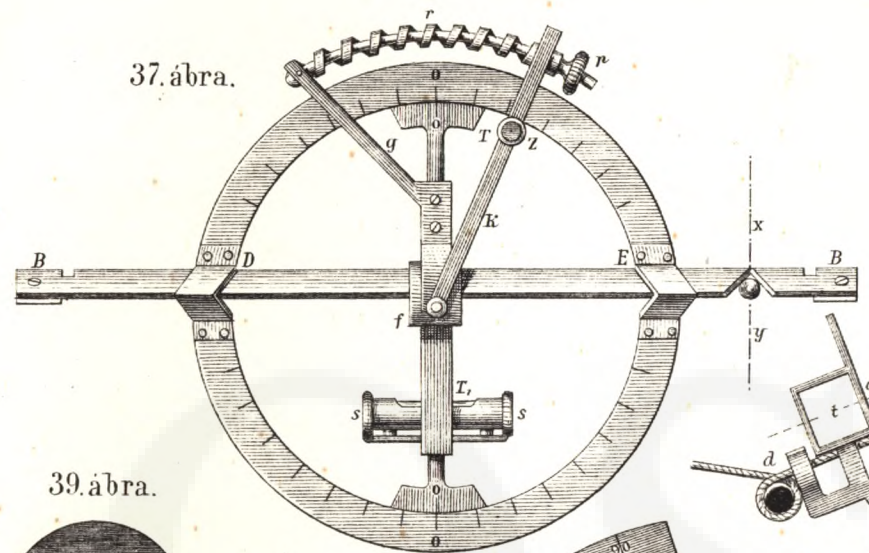

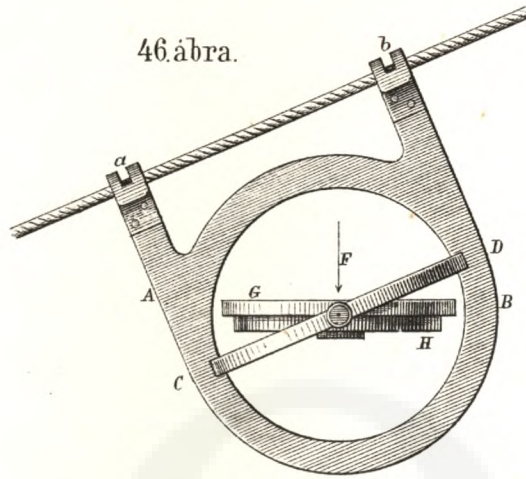

46. ábra.

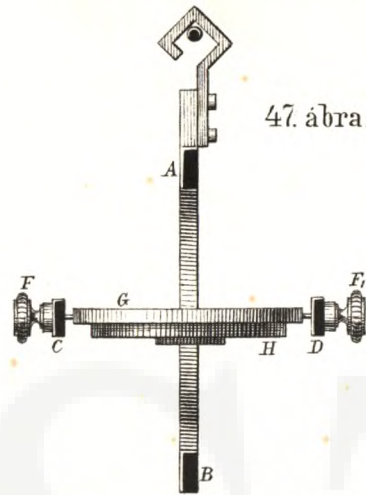

47. ábra.

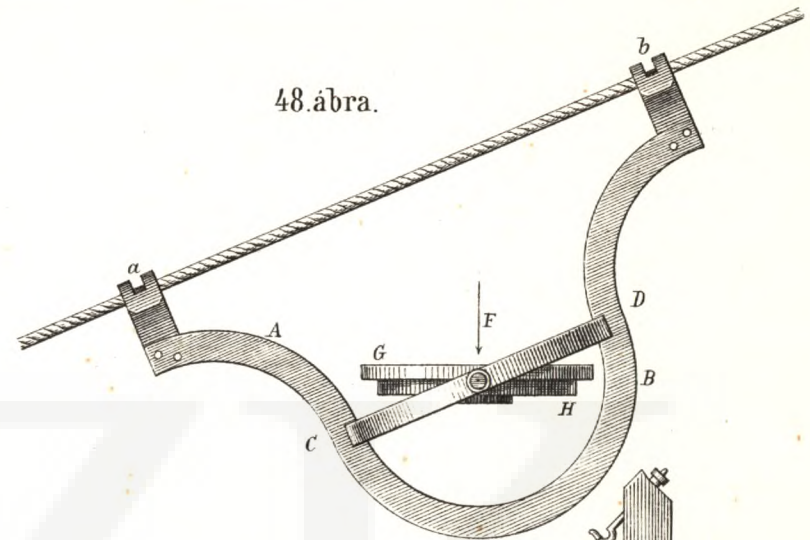

48. ábra.

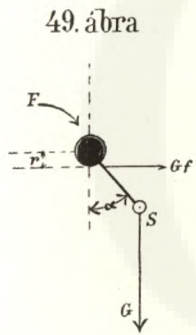

49. ábra

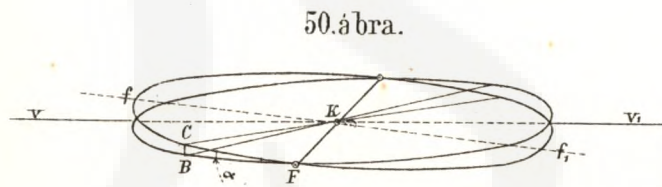

50. ábra.

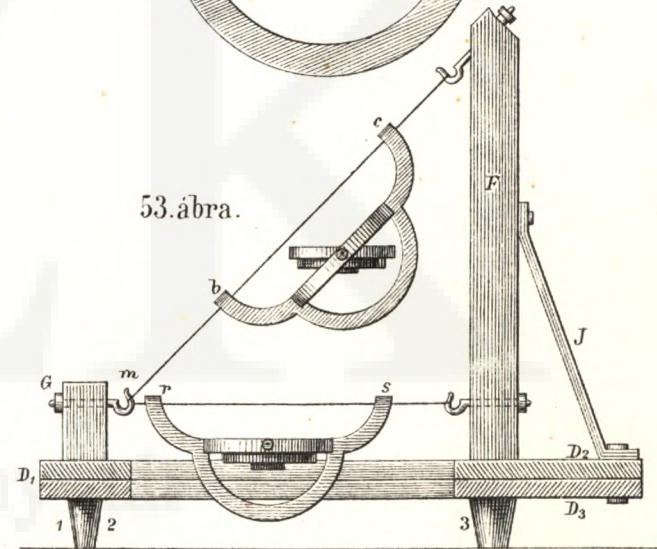

53. ábra.

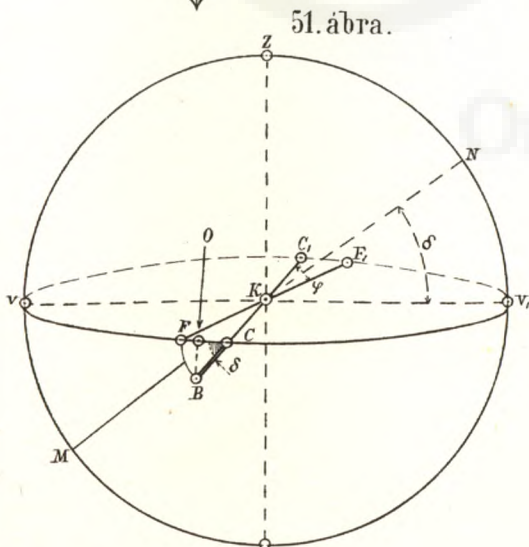

51. ábra.

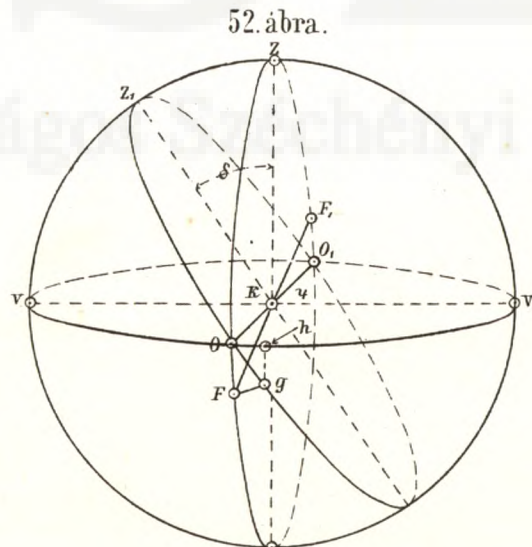

52. ábra.

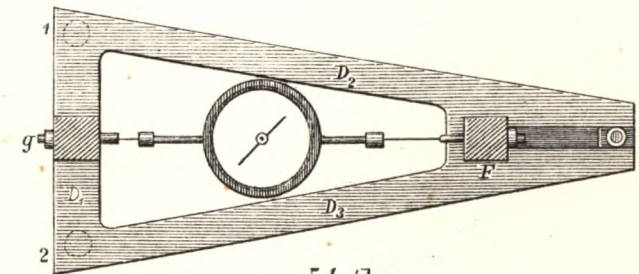

54. ábra.

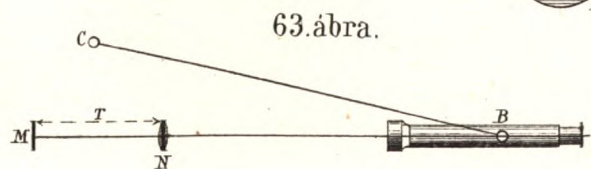
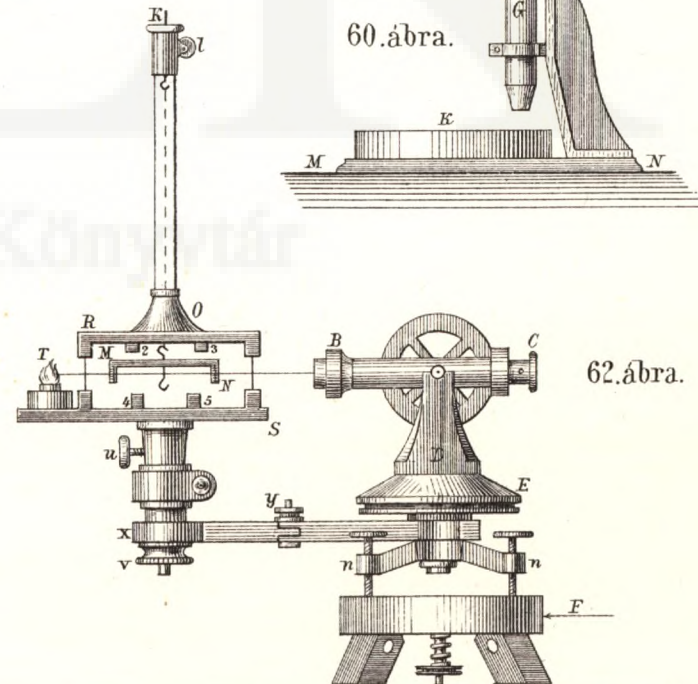
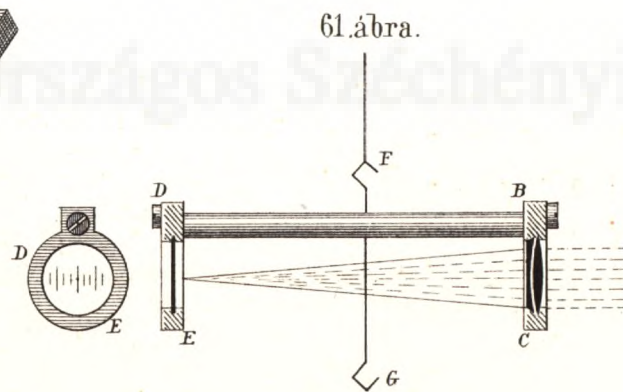
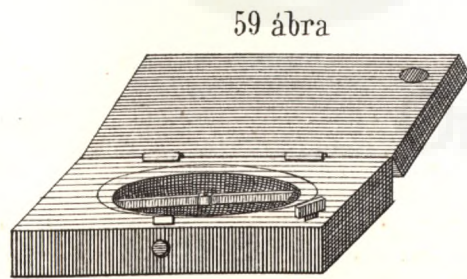
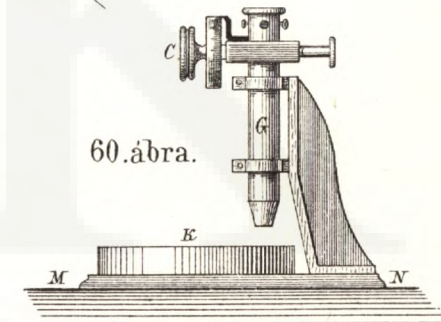
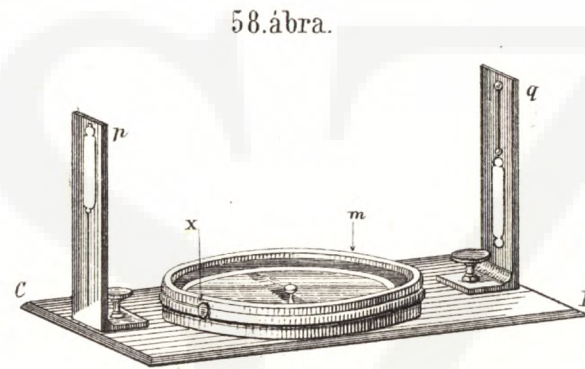
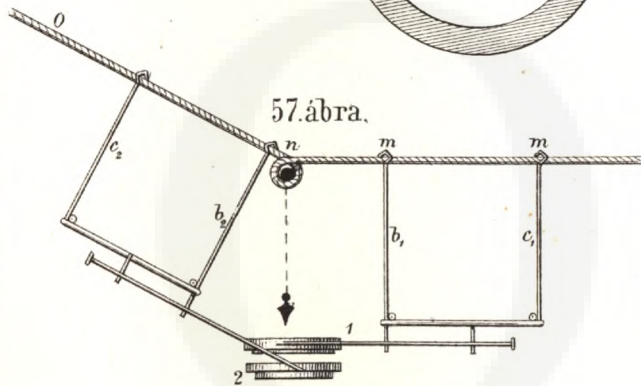
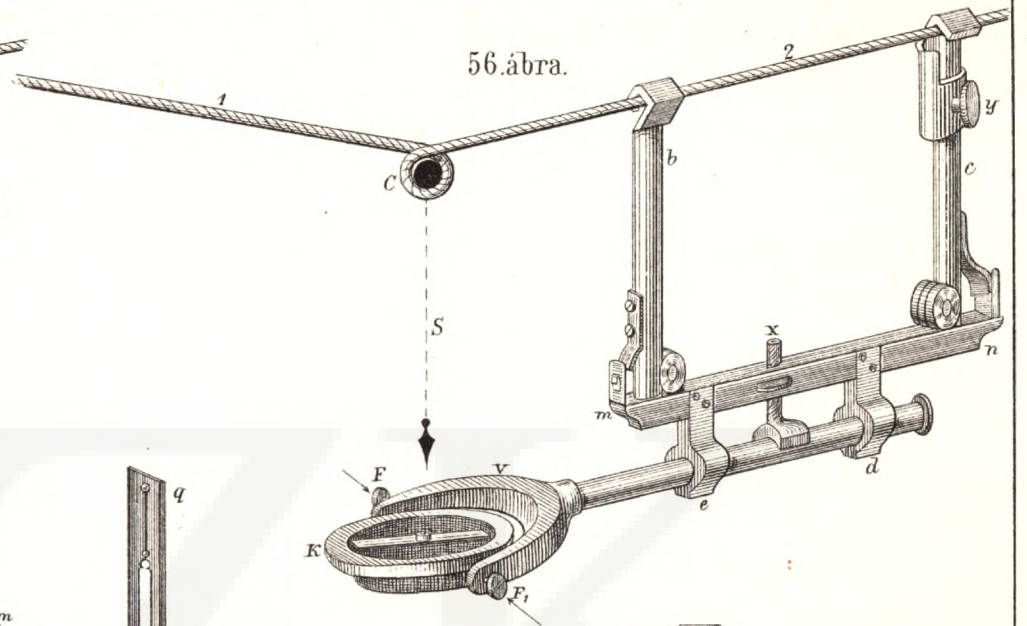
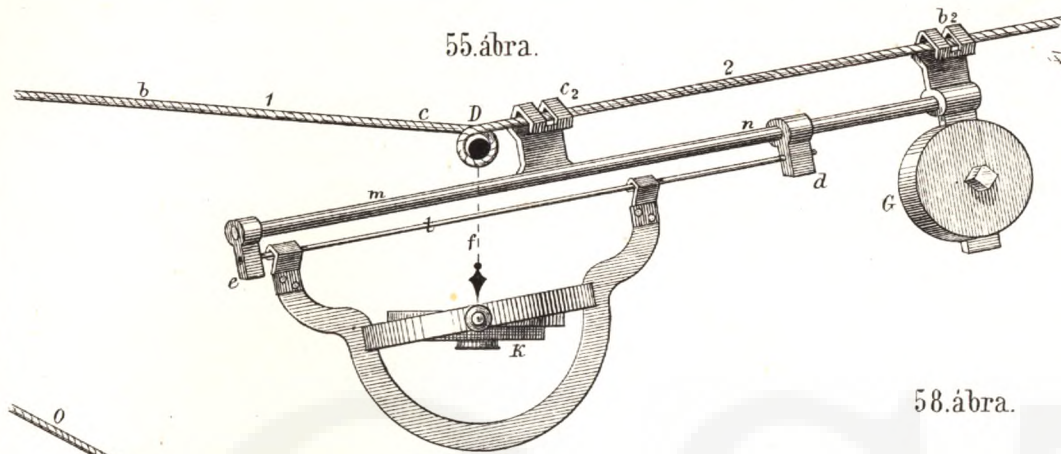

64. ábra.

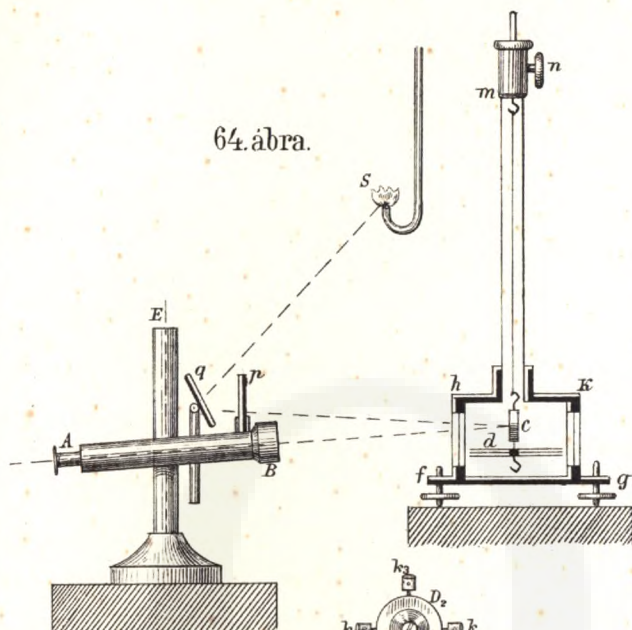

65. ábra.

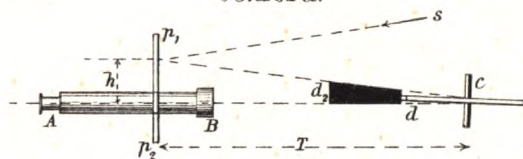

66. ábra.

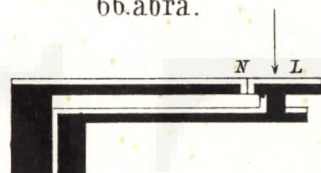

71. ábra.

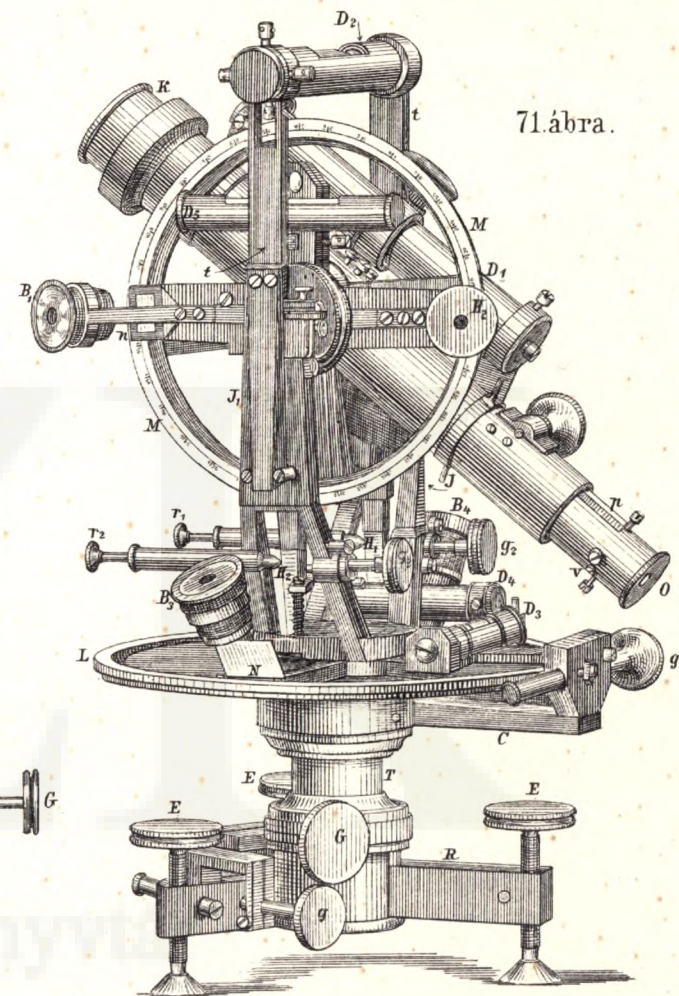

70. ábra.

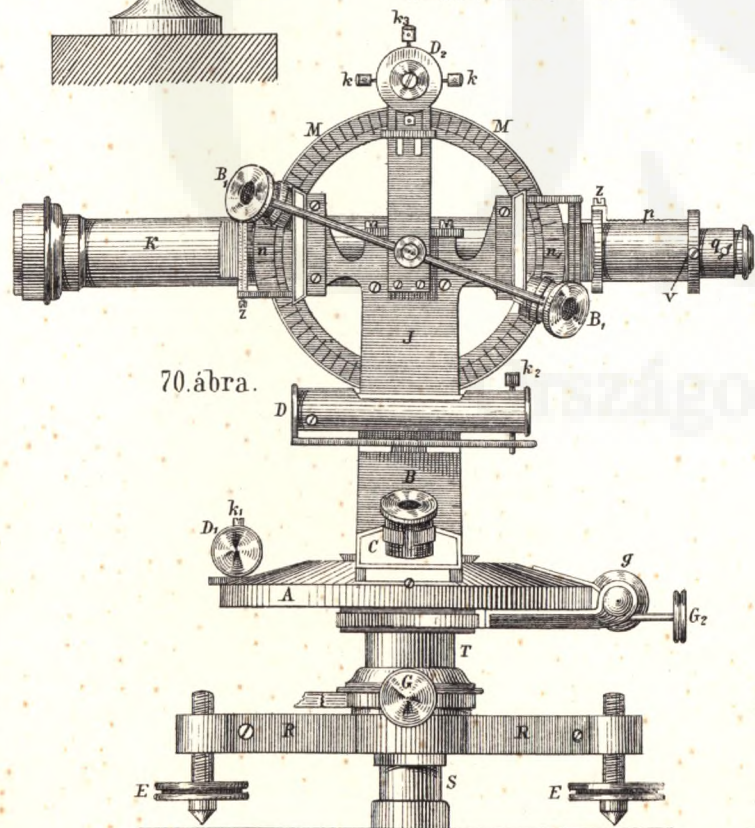

69. ábra.

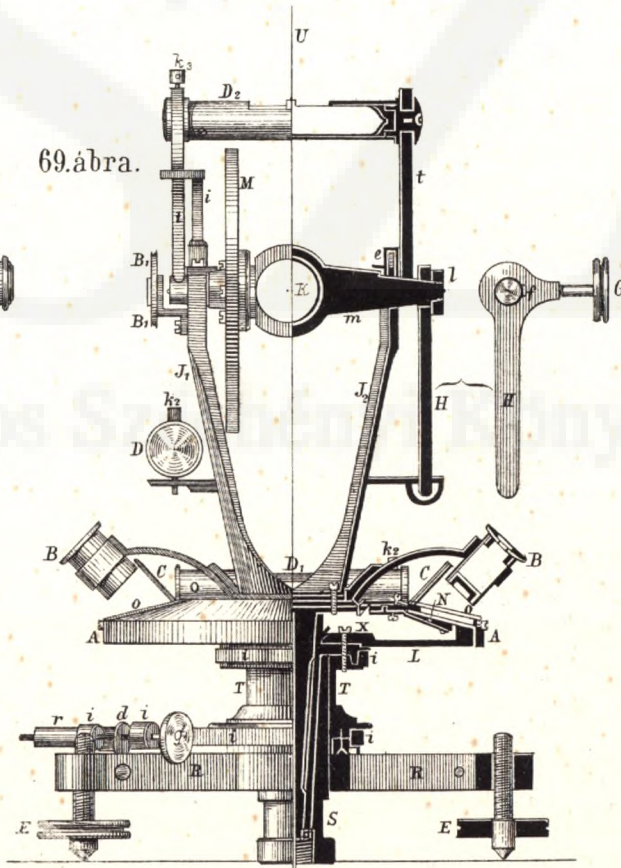

67. ábra.

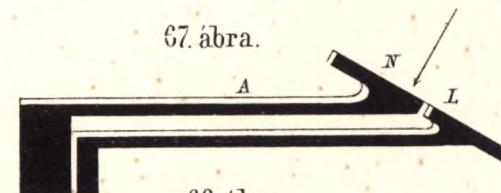

68. ábra.

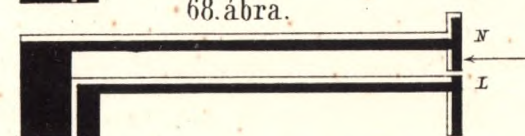

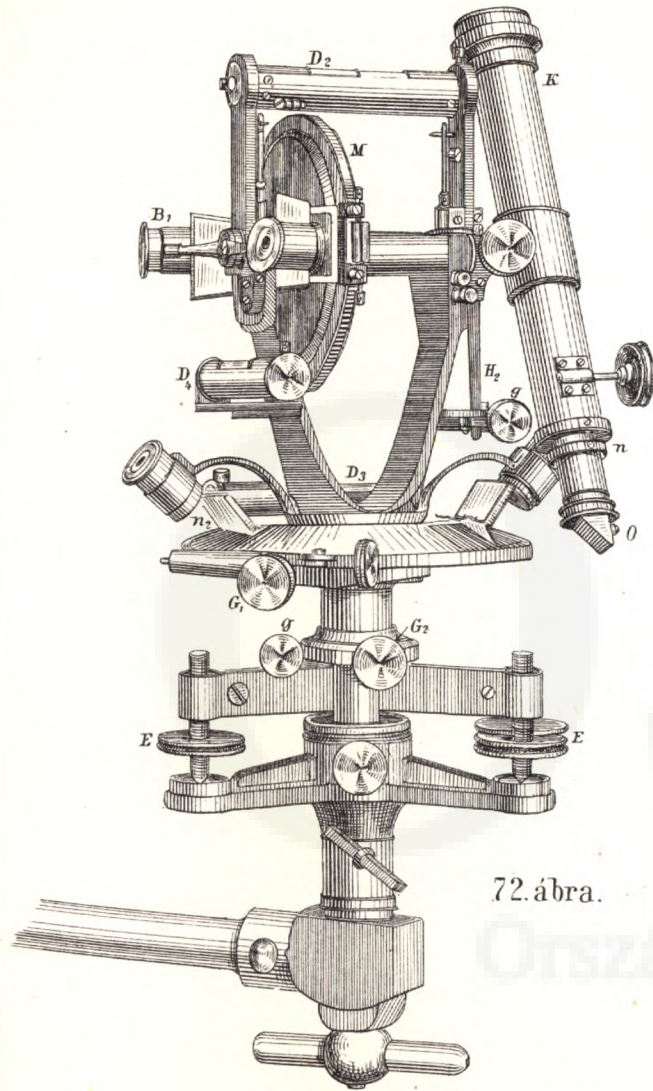

72. ábra.

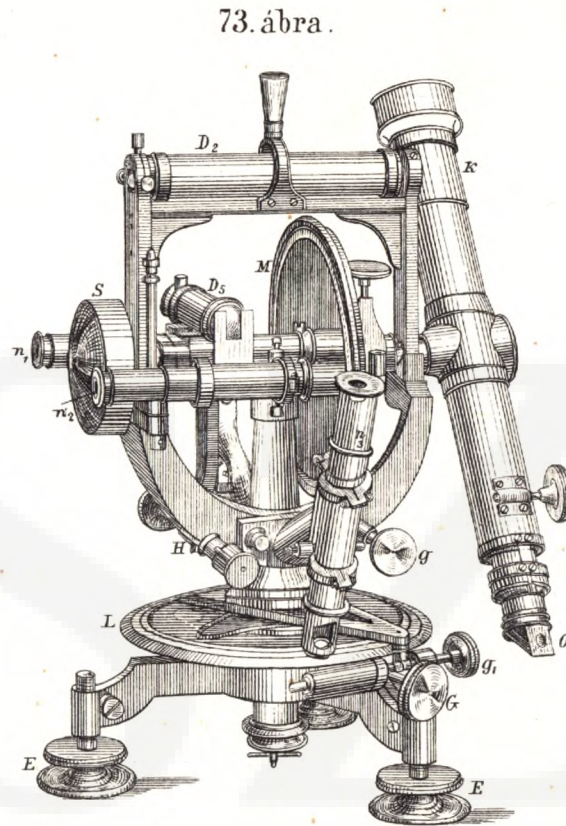

73. ábra.

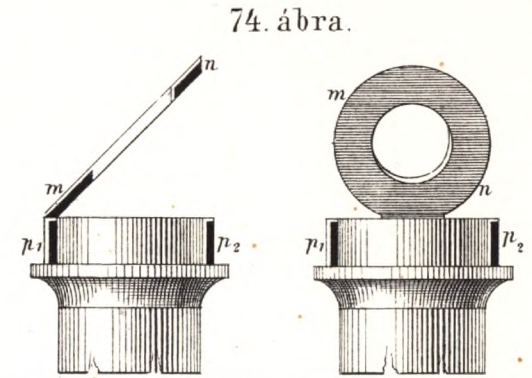

74. ábra.

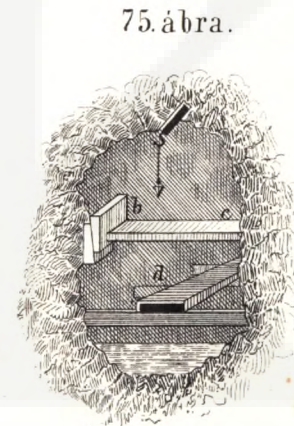

75. ábra.

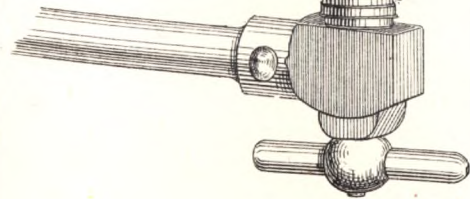

76. ábra.

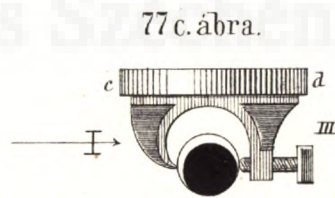

77c. ábra.

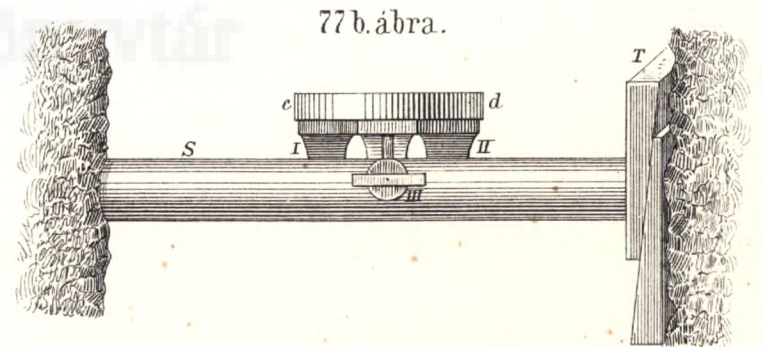

77b. ábra.

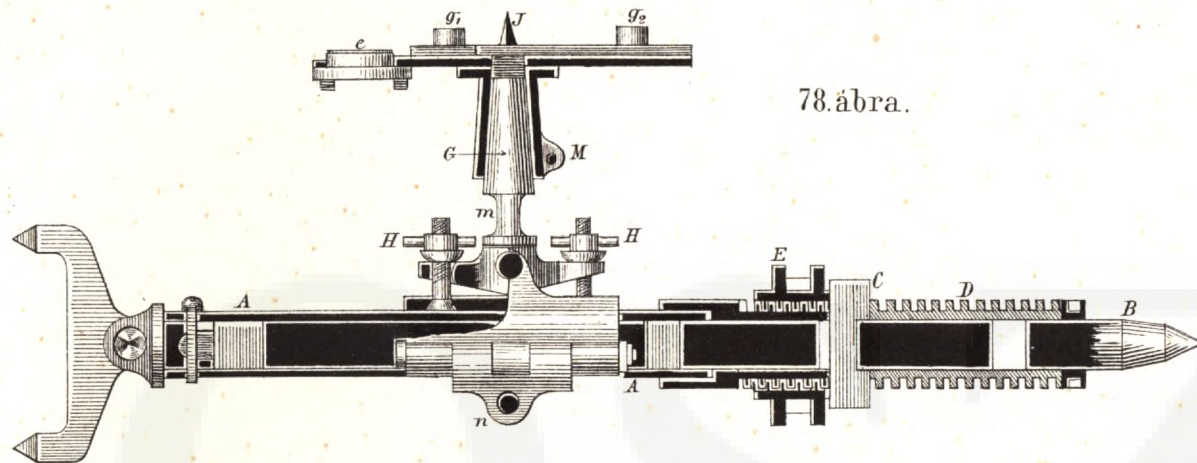

78. ábra.

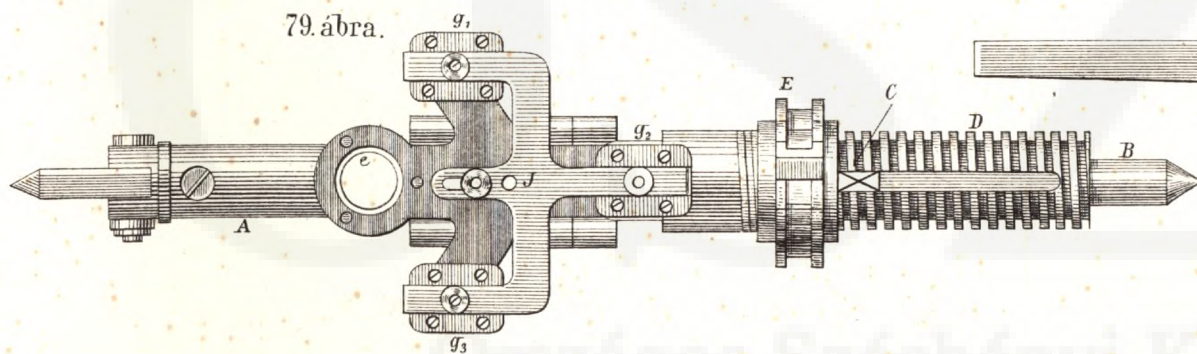

79. ábra.

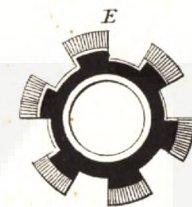

80. ábra.

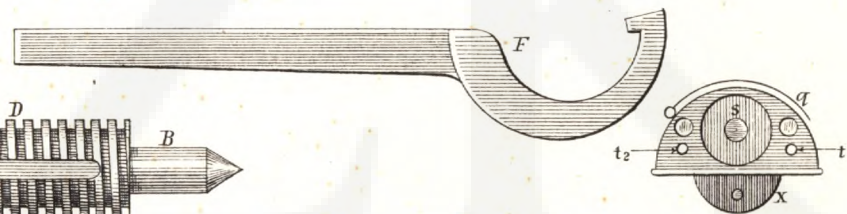
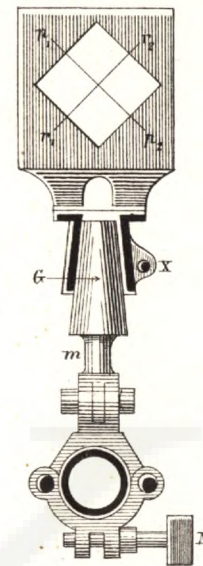

81. ábra.

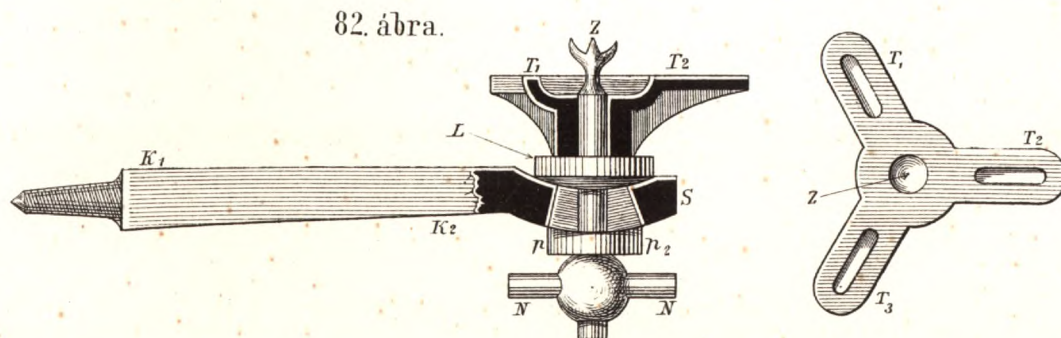

82. ábra.

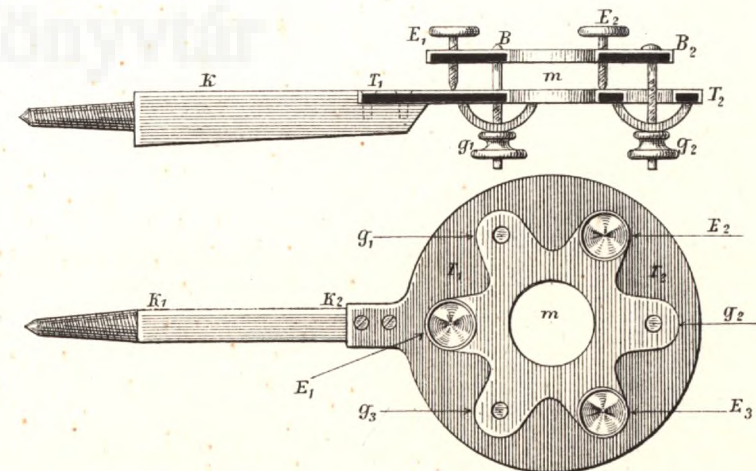

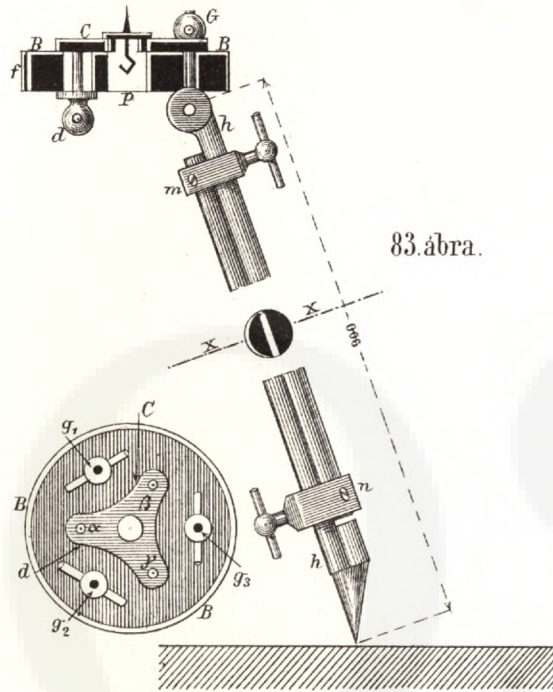

83. ábra.

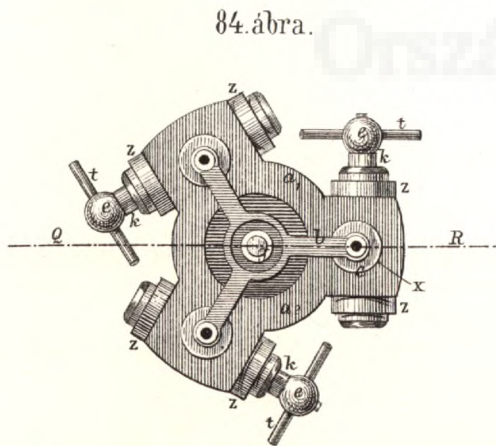

84. ábra.

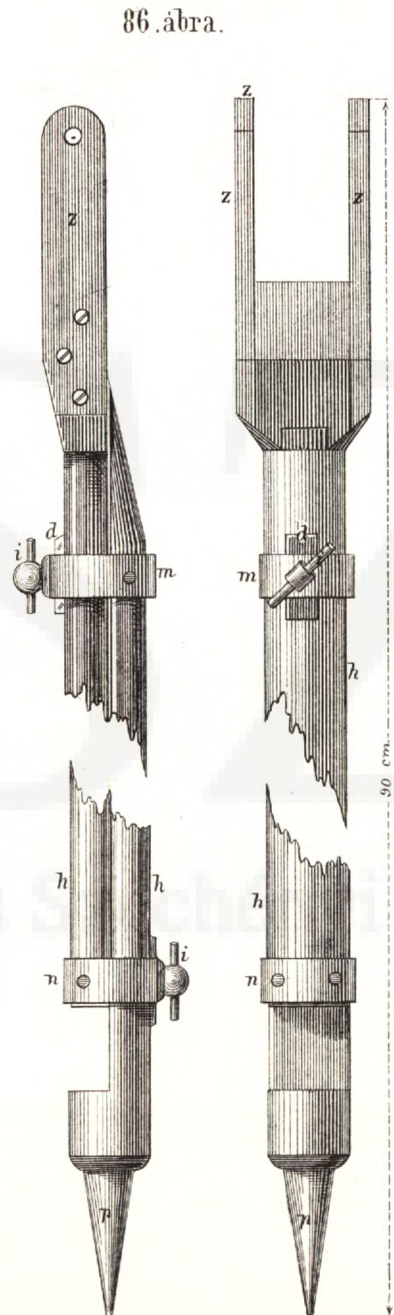

86. ábra.

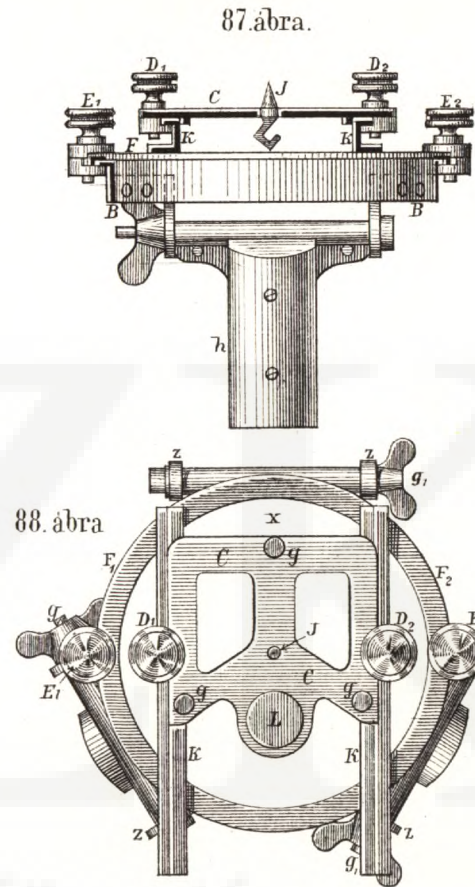

87. ábra.

88. ábra

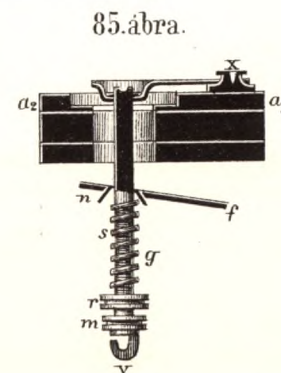

85. ábra.

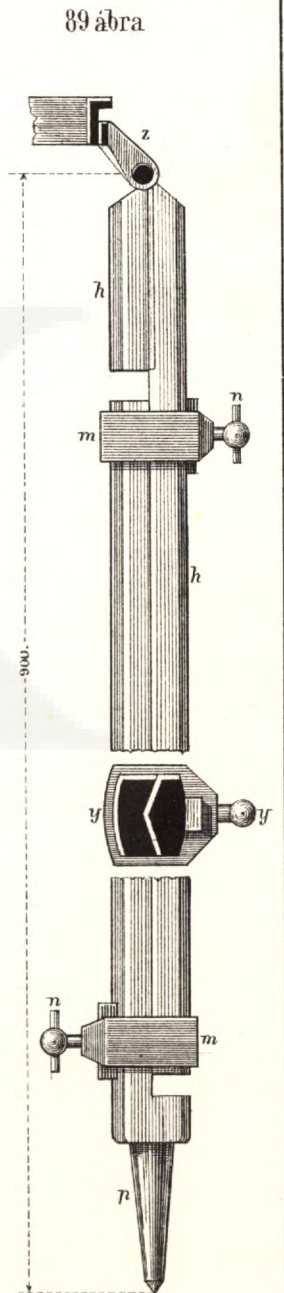

89. ábra

90. ábra.

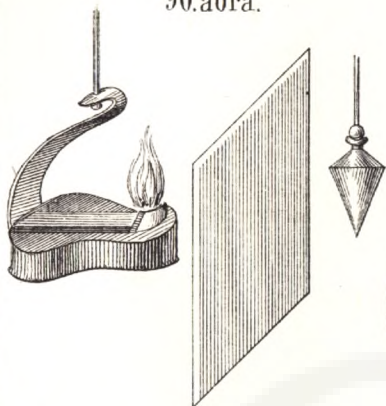

91. ábra.

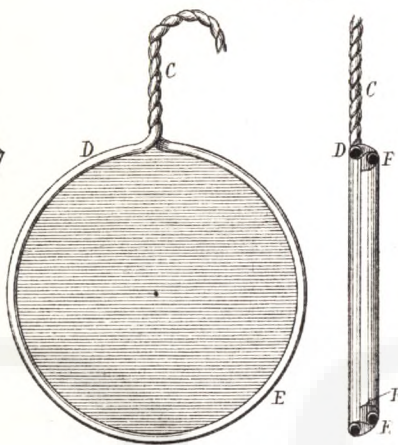

92. ábra.

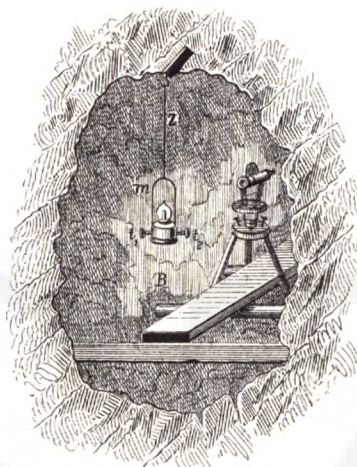

93. ábra.

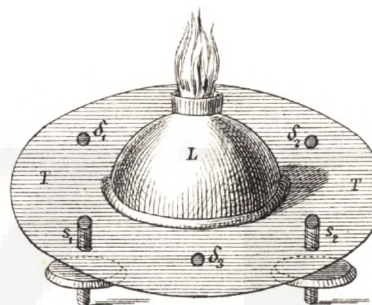

94. ábra.

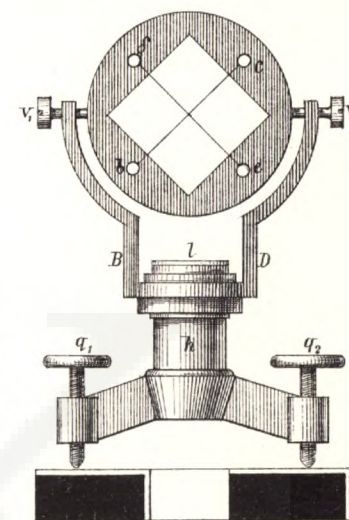

95. ábra.

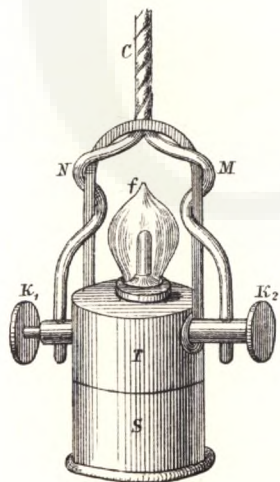

96. ábra.

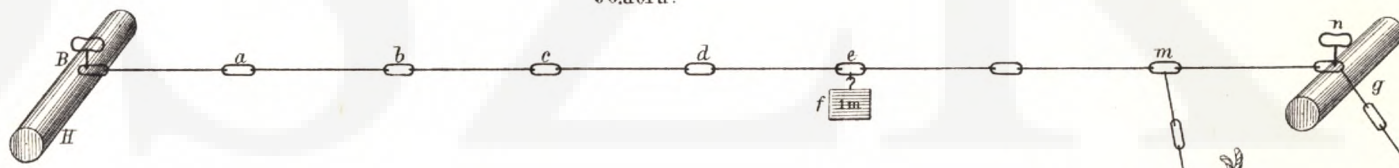

97. ábra.

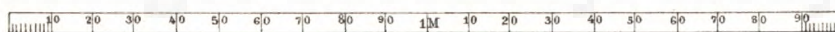

98 B. ábra.

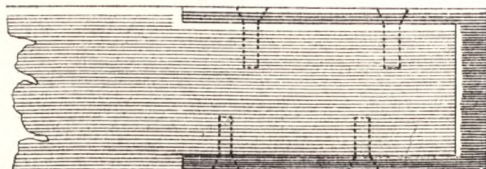

98 C. ábra.



99. ábra.

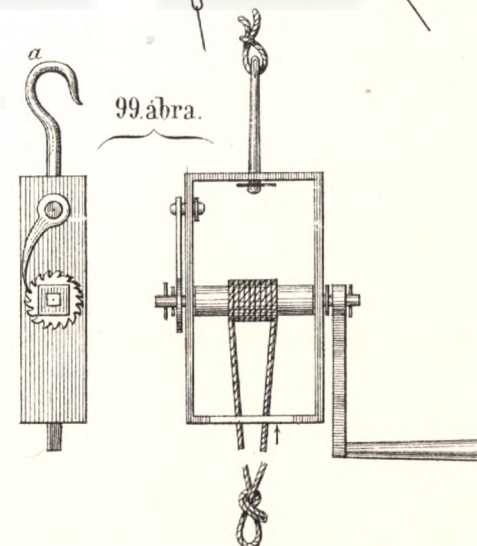

100. ábra.

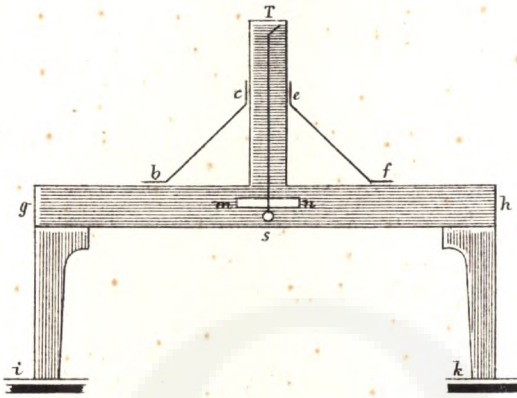

105. ábra.

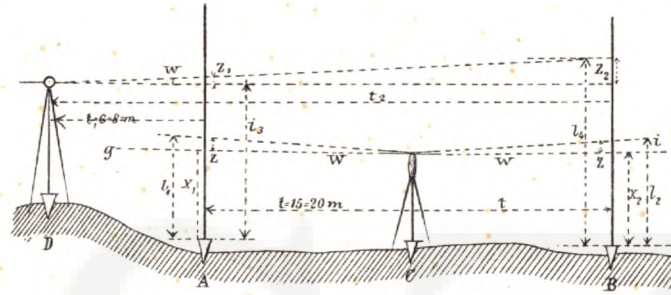

101. ábra.

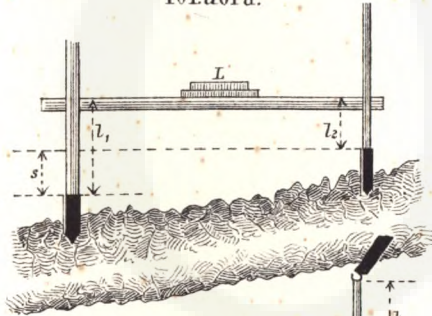

104. ábra.

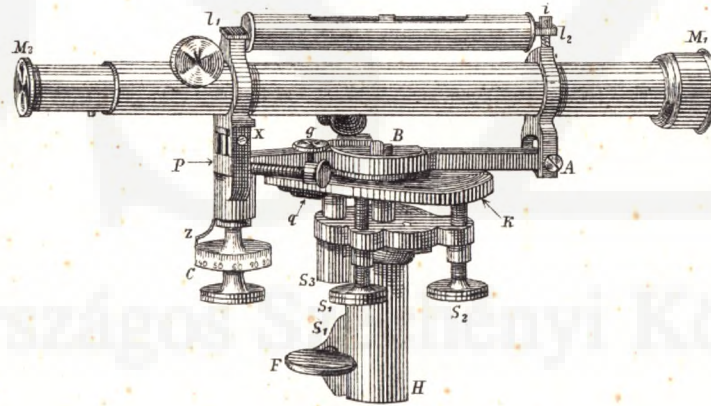

102. ábra.

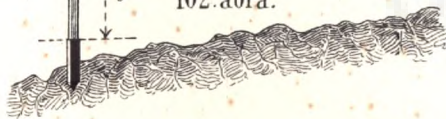

103. ábra.

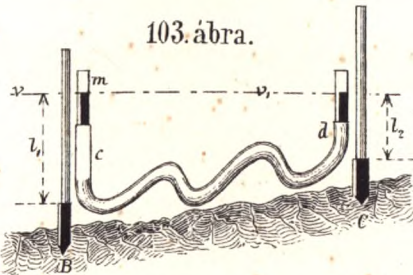

106. ábra.

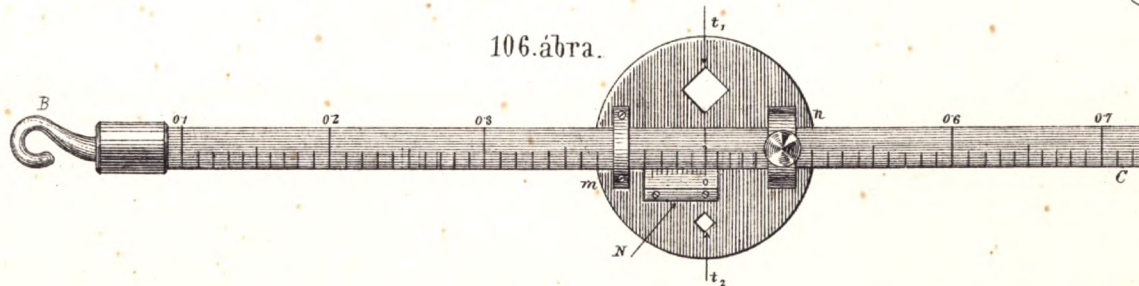

107. ábra.



108. ábra.

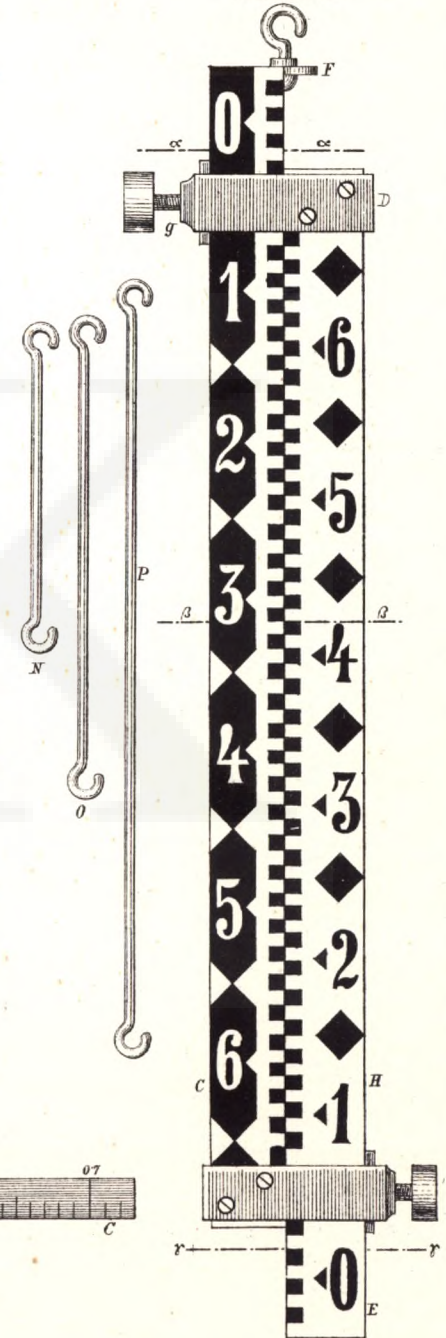

109. ábra

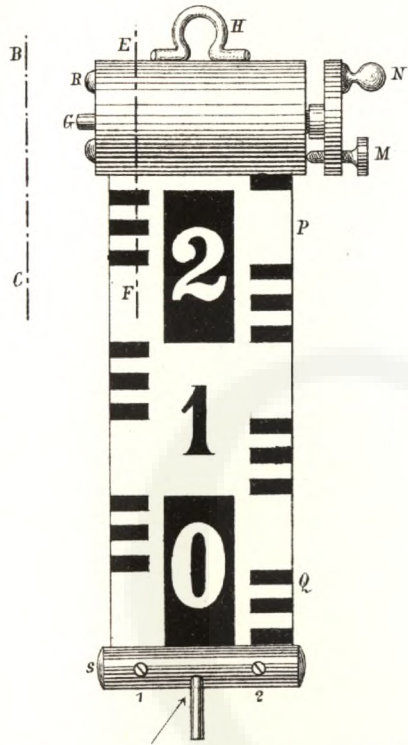

110. ábra.
BC nézet



111. ábra.
EF metszet.

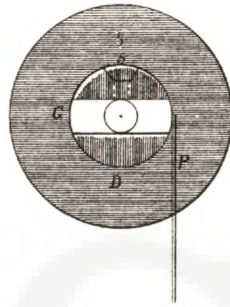

112. ábra.

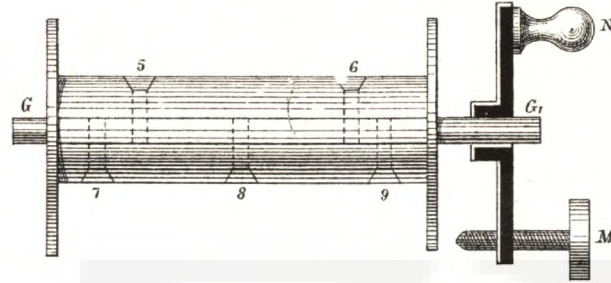

113. ábra

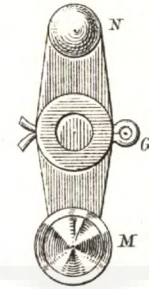

114. ábra.
BC metszet.

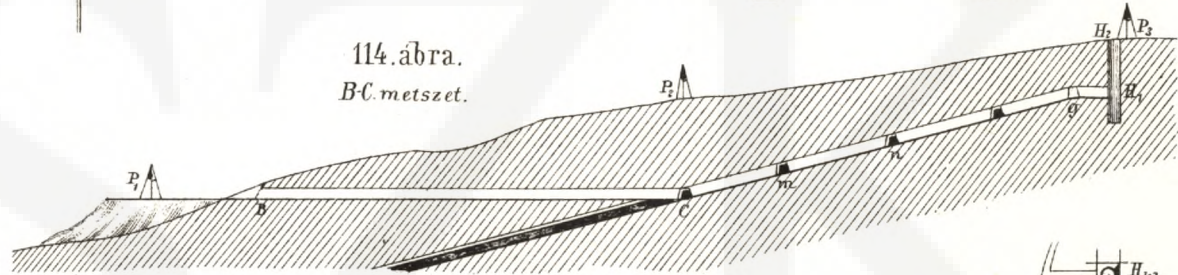

115. ábra.

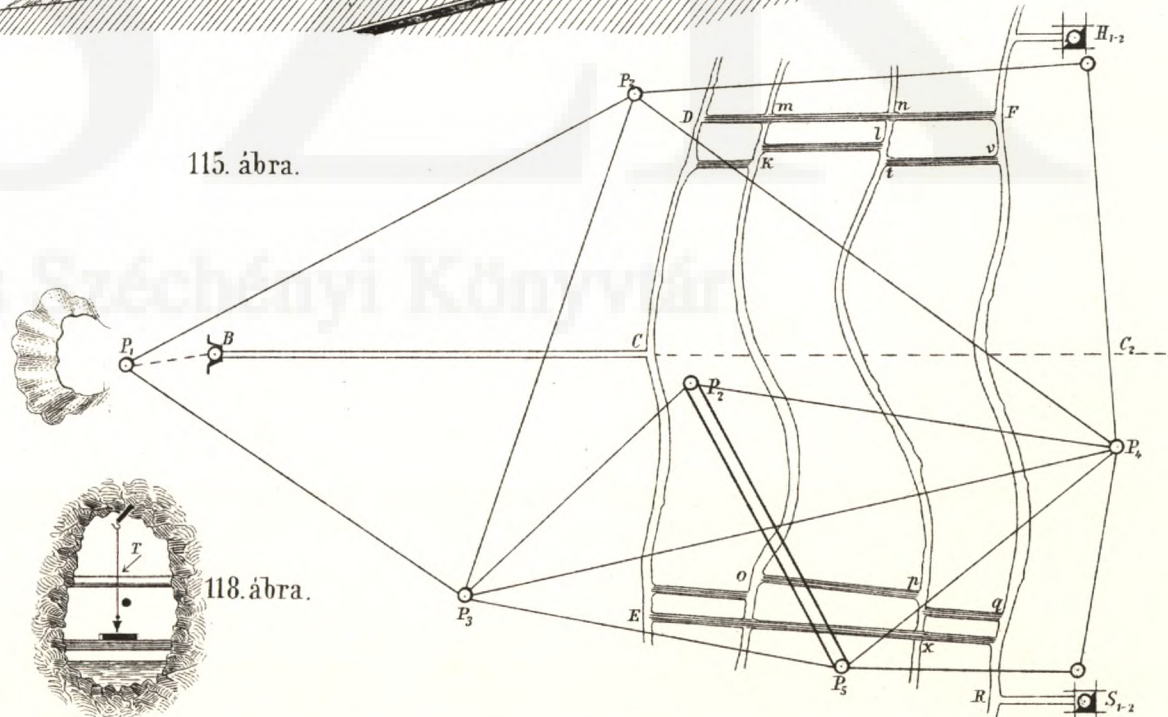

116. ábra.

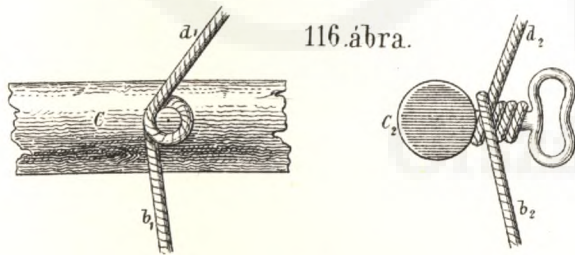

117. ábra.

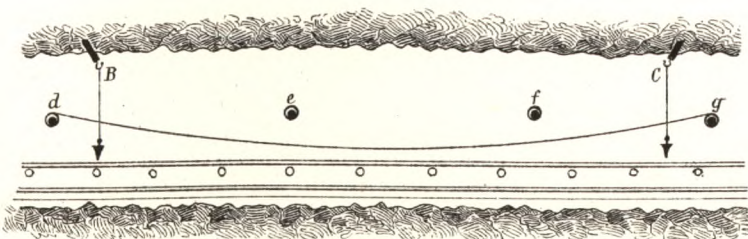

118. ábra.

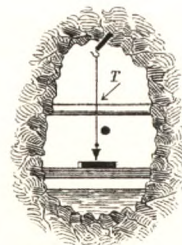

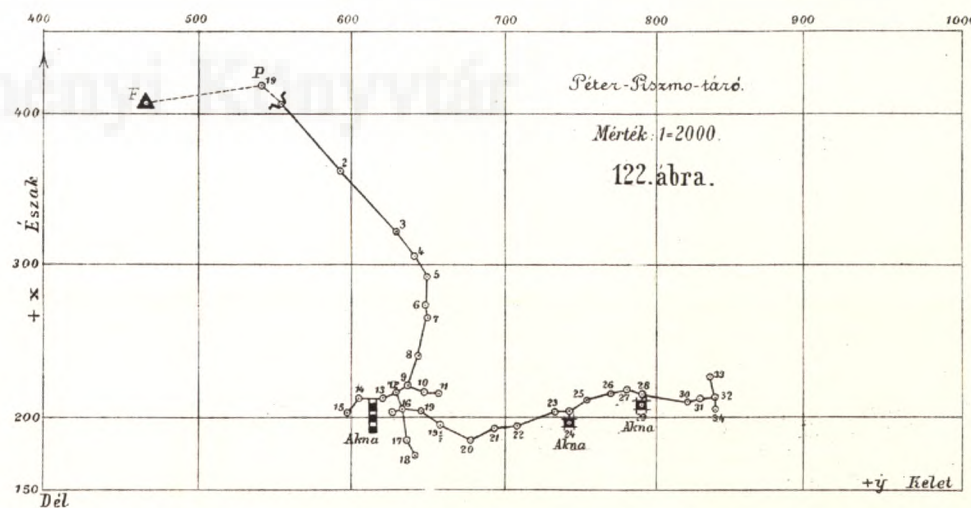
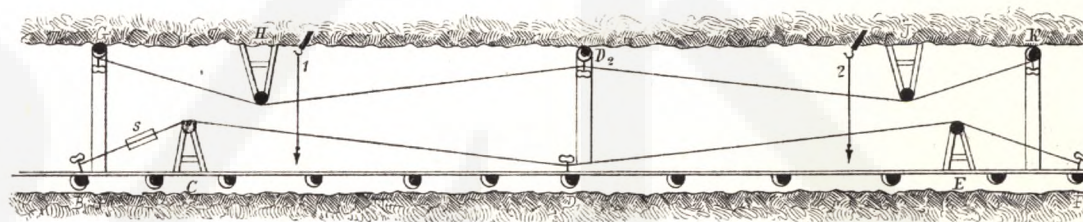
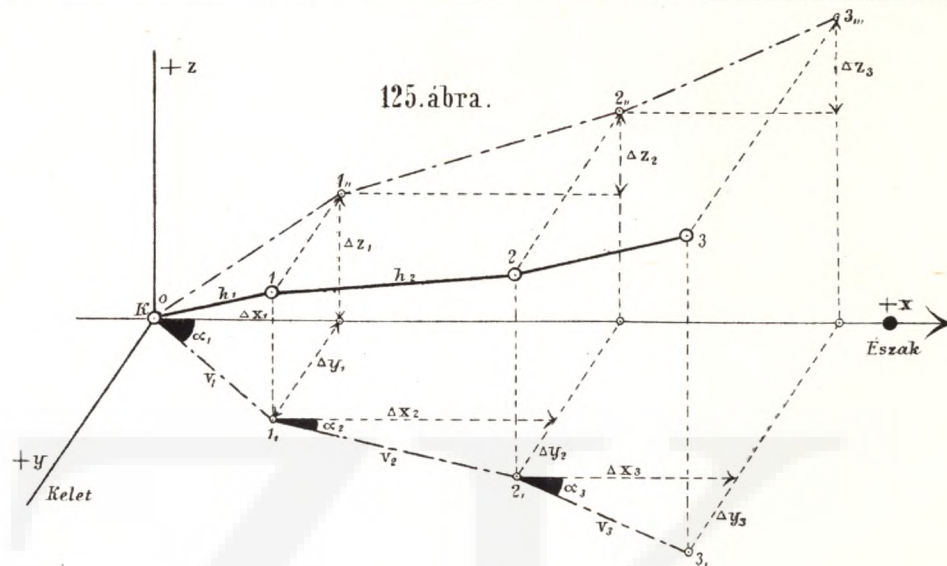
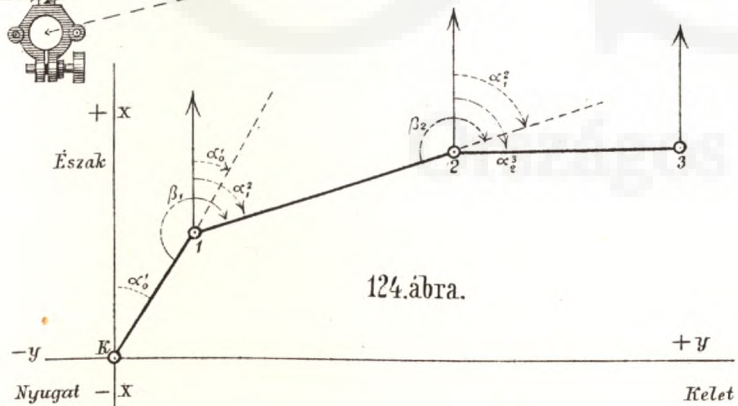
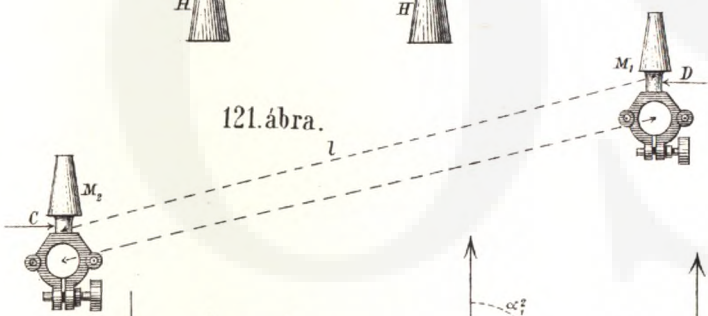
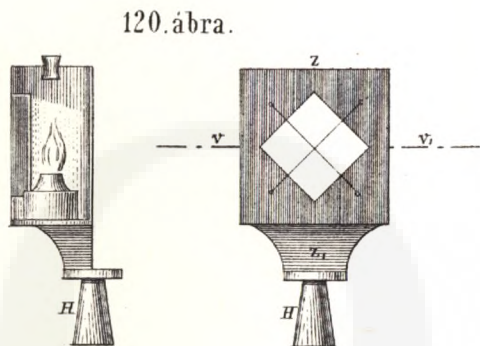
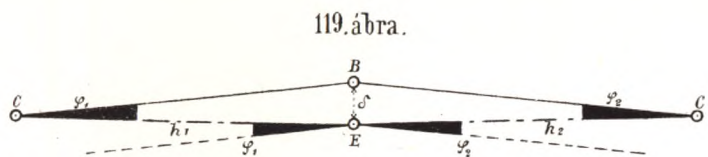

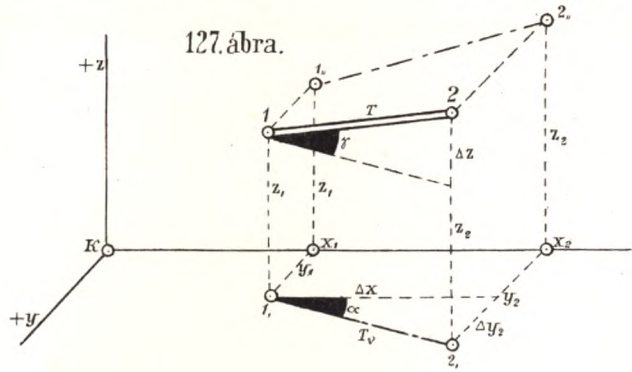

127. ábra.

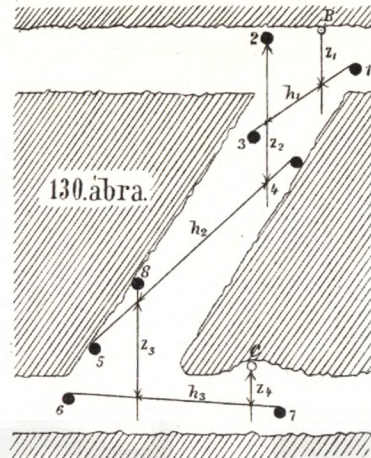

130. ábra.

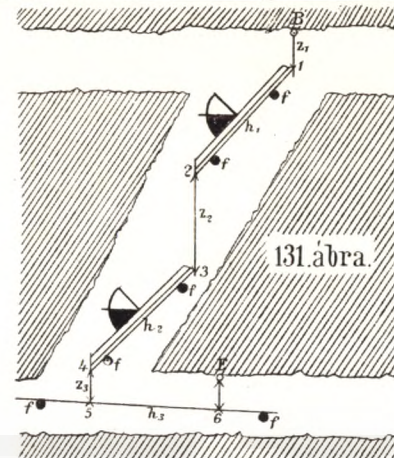

131. ábra.

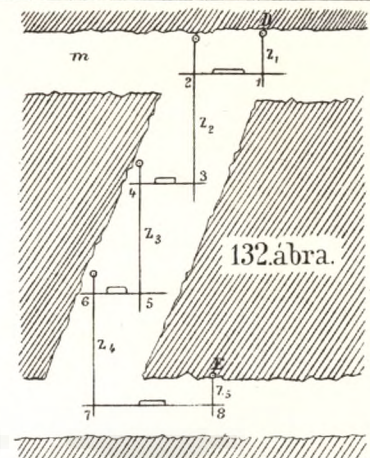

132. ábra.

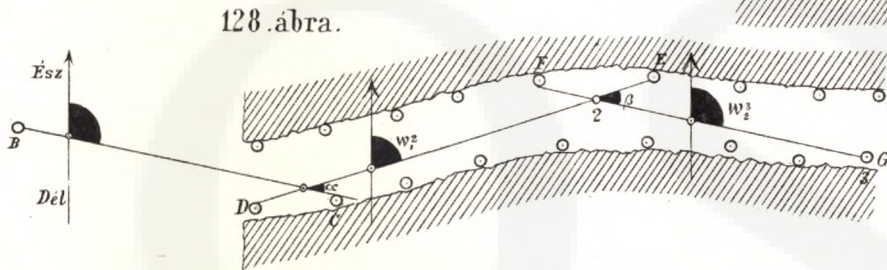

128. ábra.

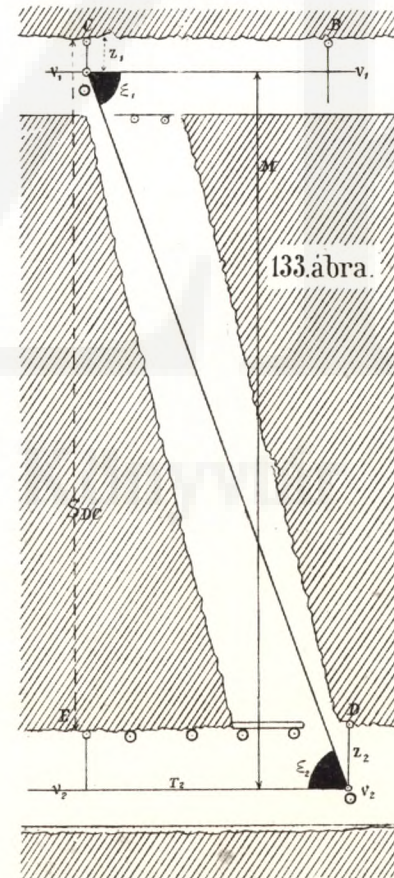

133. ábra.

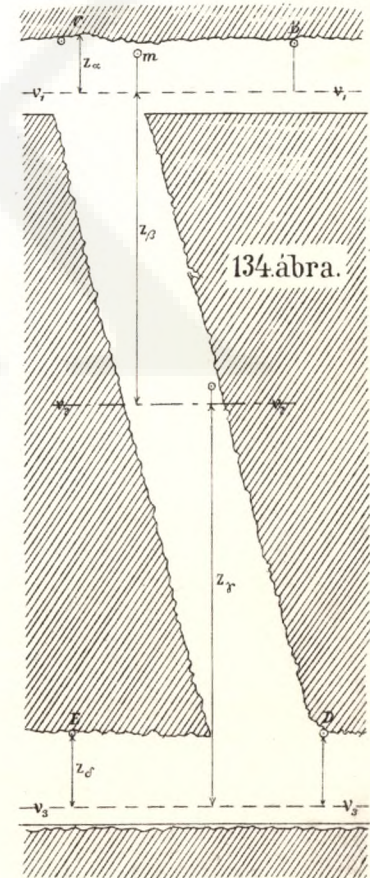

134. ábra.

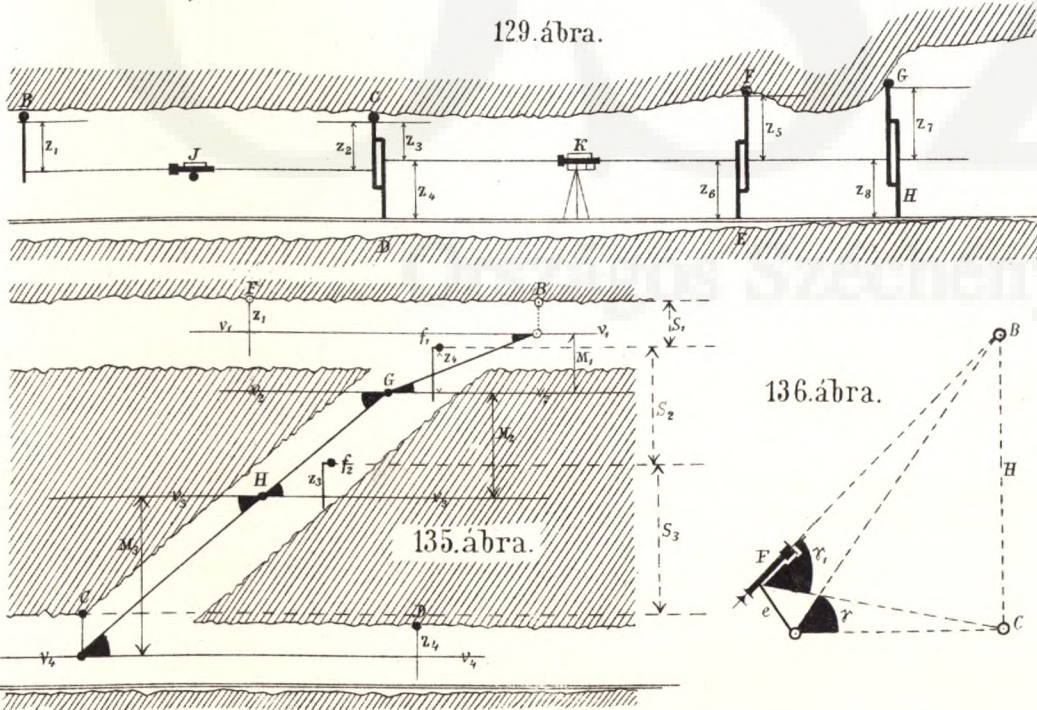

129. ábra.

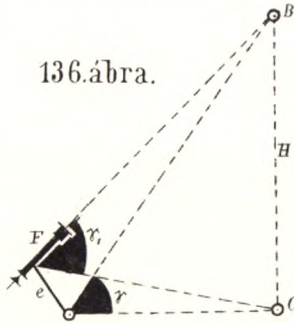

135. ábra.

136. ábra.

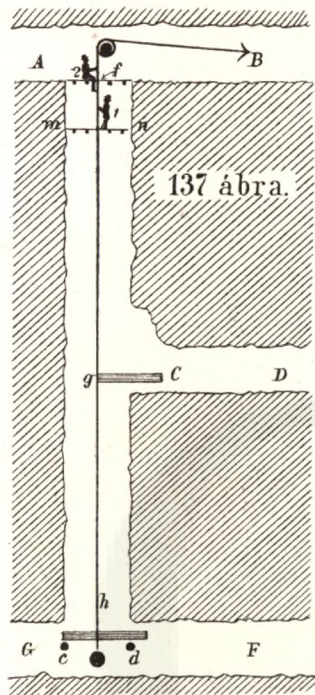

137. ábra.

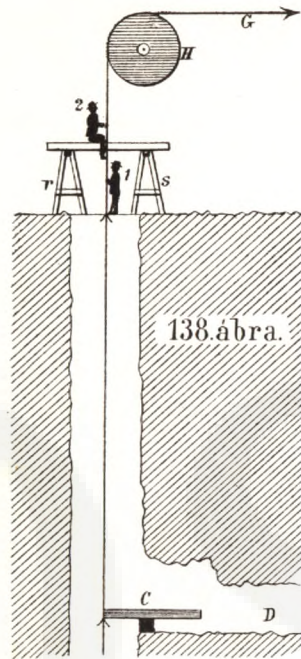

138. ábra.

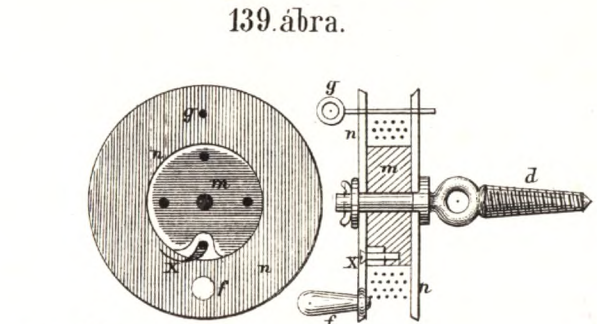

139. ábra.

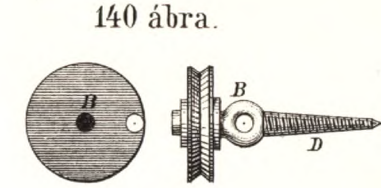

140. ábra.

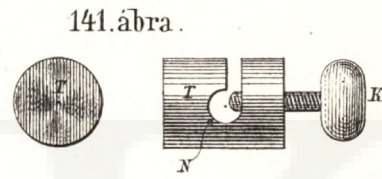

141. ábra.

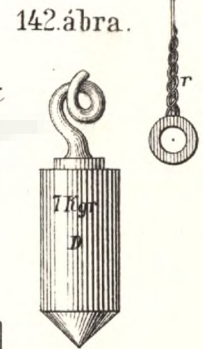

142. ábra.

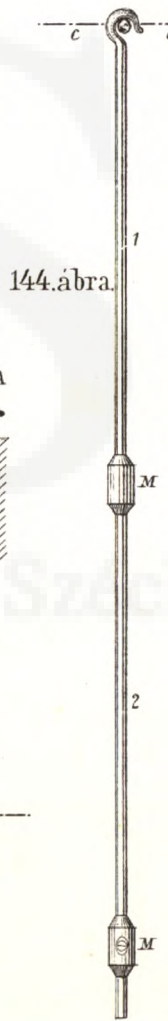

144. ábra.

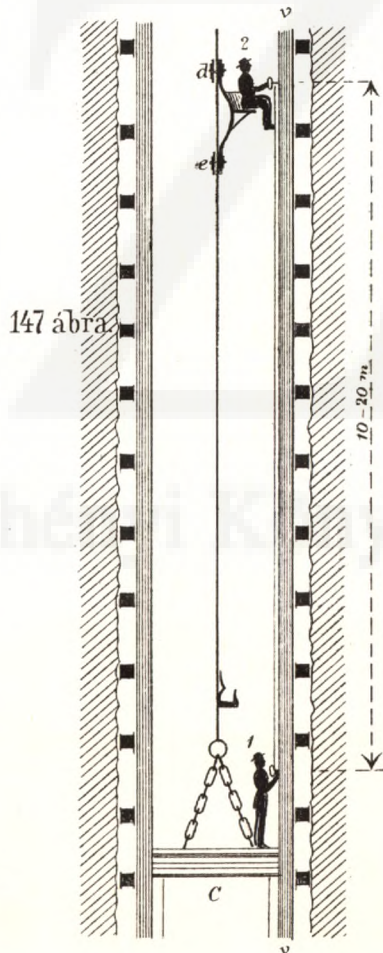

147. ábra.

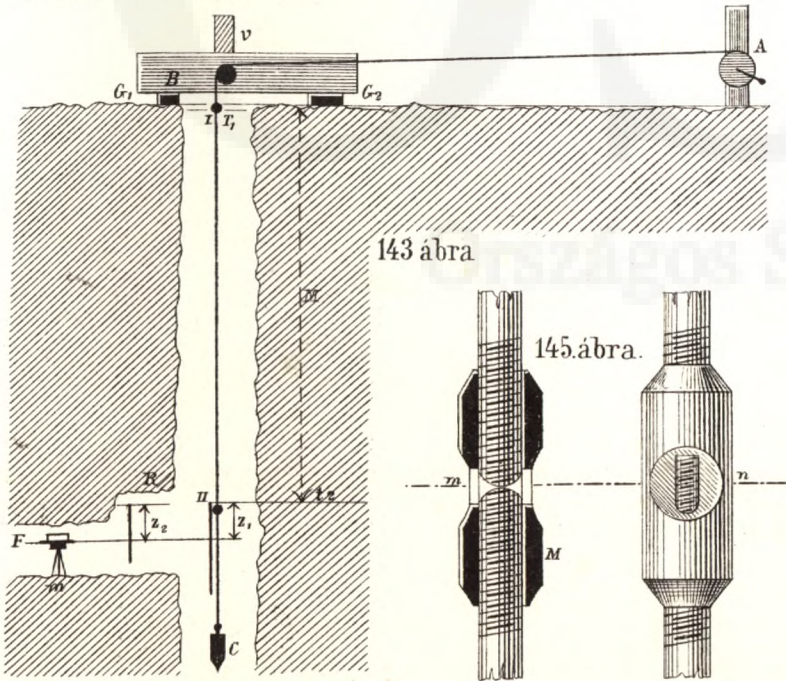

143. ábra.

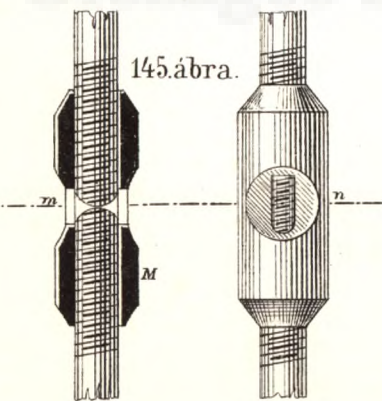

145. ábra.

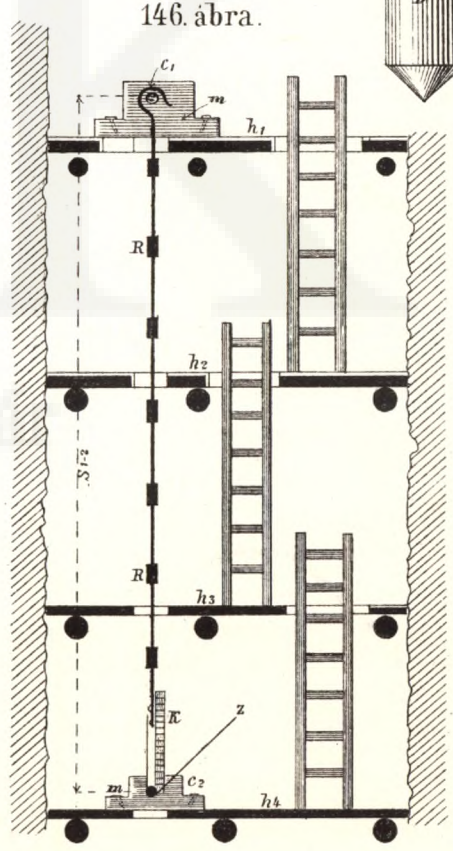

146. ábra.

148. ábra.

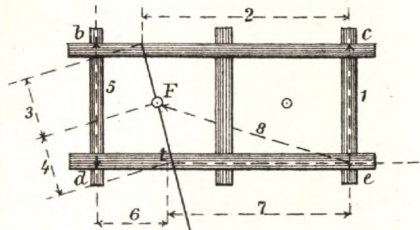

149. ábra.

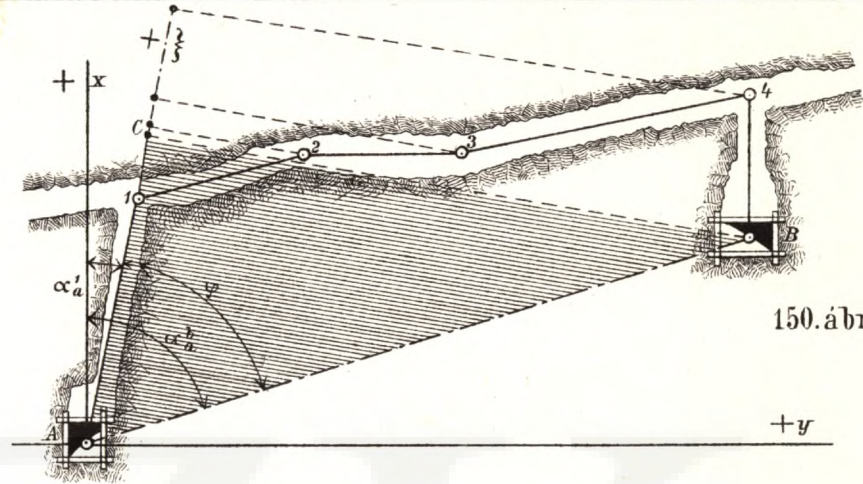
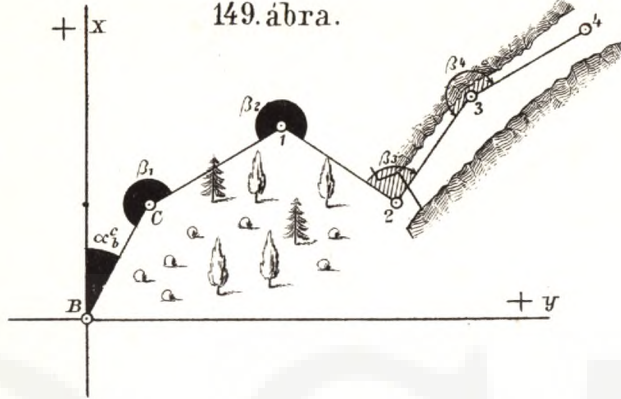

150. ábra.

151. ábra.

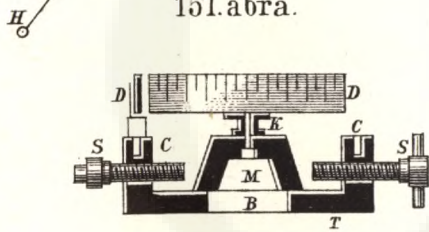

154. ábra.

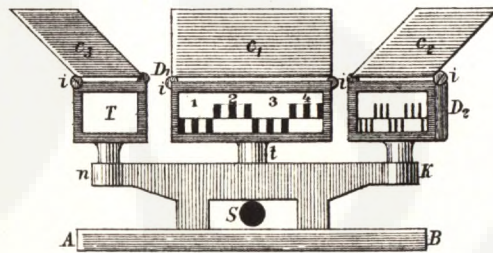

155. ábra.

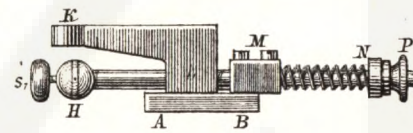

158. ábra.

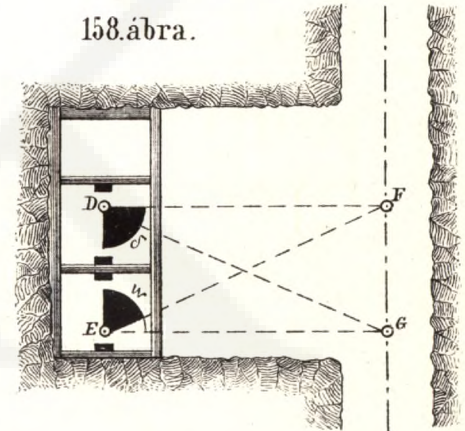

152. ábra.

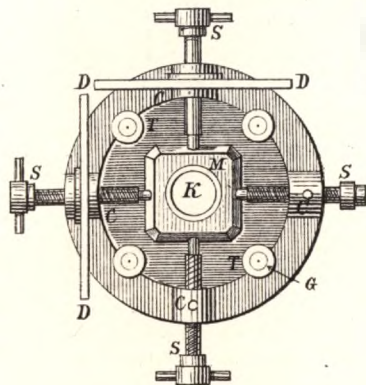

156. ábra.

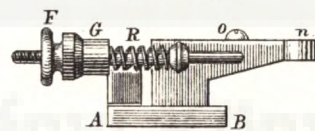

153. ábra.

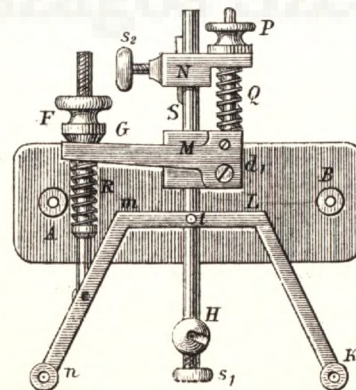

157. ábra.

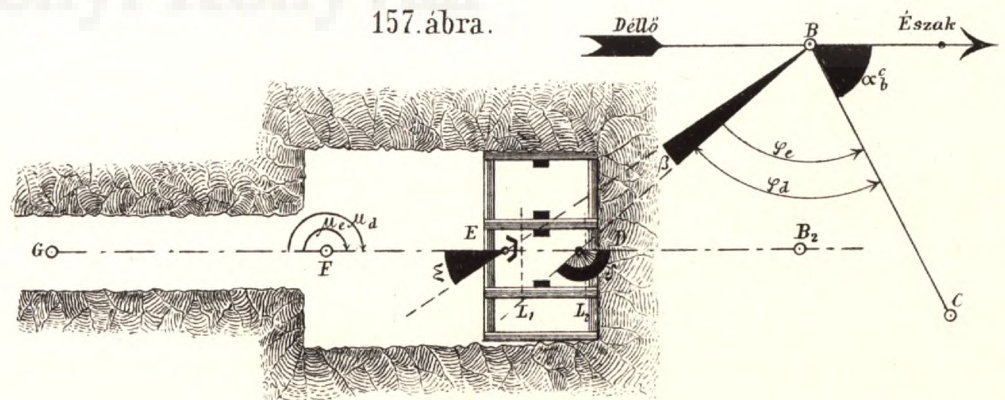

Jelölés

Átnézeti térképen.



Széntelep

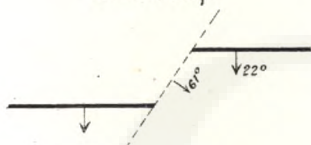

Kutatások

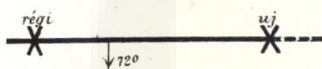

Kutató árok



Tároló



Akna



Tűrés



Kutatókör

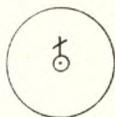

Háromszöglető pont



Bányatelek és határ



Vasút



Országút

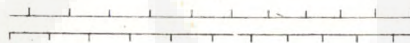

Kézelt út



Bányák

✕ Kincstári

✕ magán

✕ felhagyott

○ Arany

◁ Ezüst

♀ Kéneseő

♀ Réz

♂ Vaso

♂ Ólom

4 Sn

♂ Kén

⊖ Kőso

○ Timsó

* Kősozin

+ Barnaszin

x Tőzeg

Korpadások.



Nagyolvasztó



Kavasító



Öntőmű



Fúró



Kokozoló



Kengermű



Gépműhely



Tó



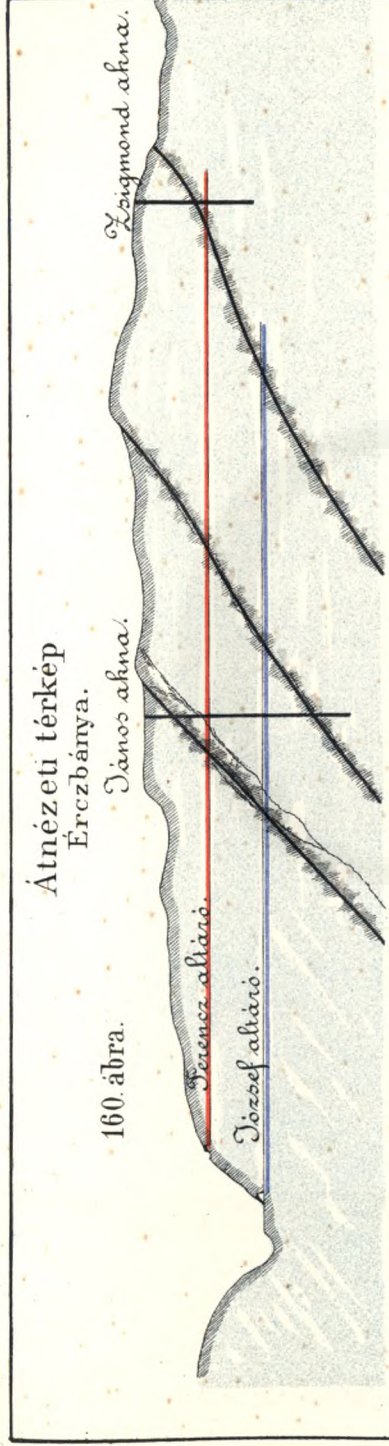

159. ábra.

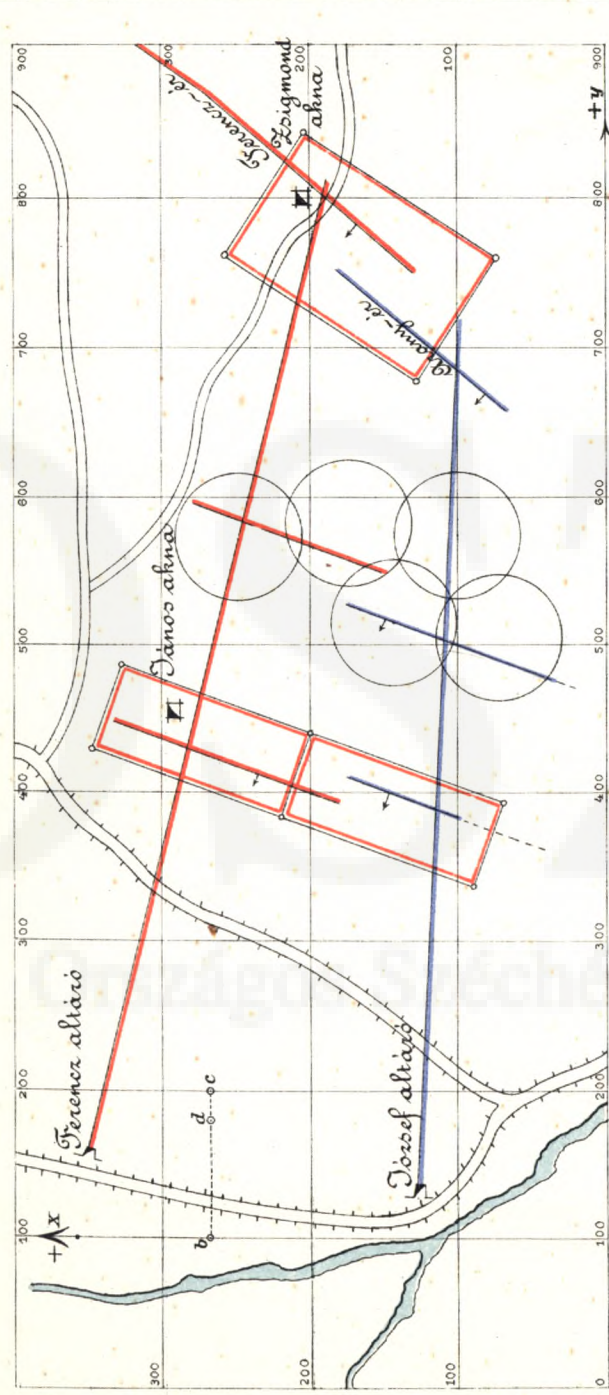

162. ábra.

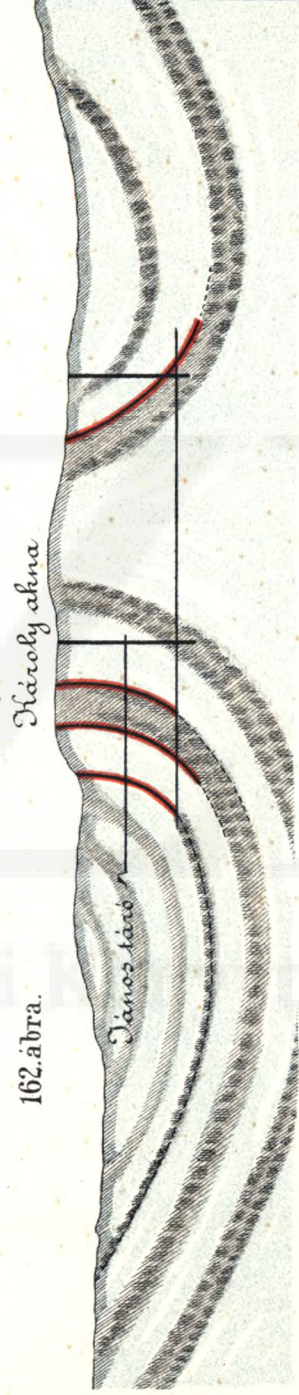

161. ábra.

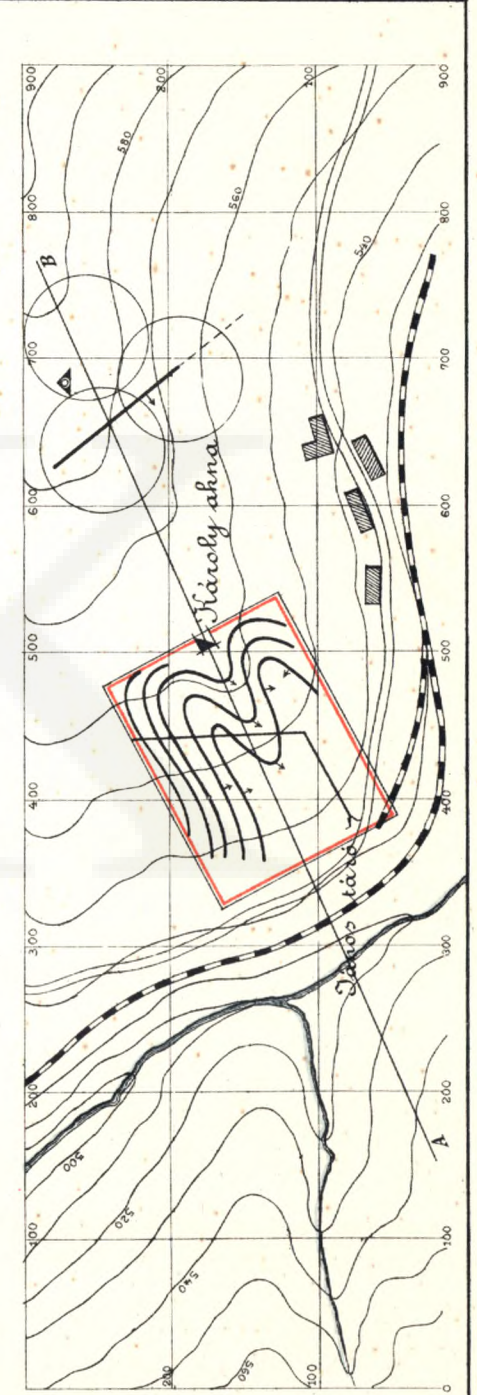

Jelölés

Részletes térképen.

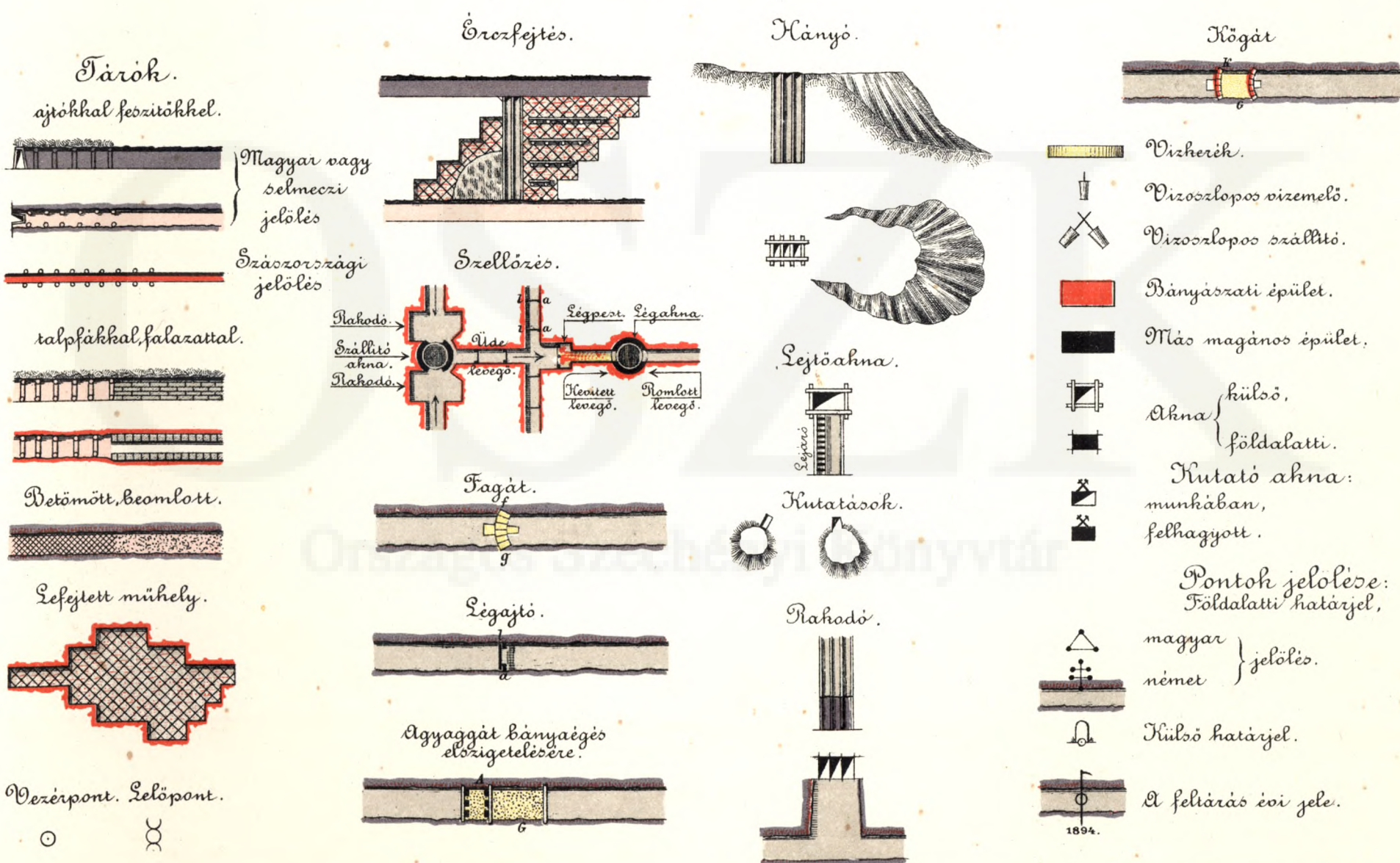

Átnevezeti térkép több érrel és több bánya szinttel, Szászország

165 ábra

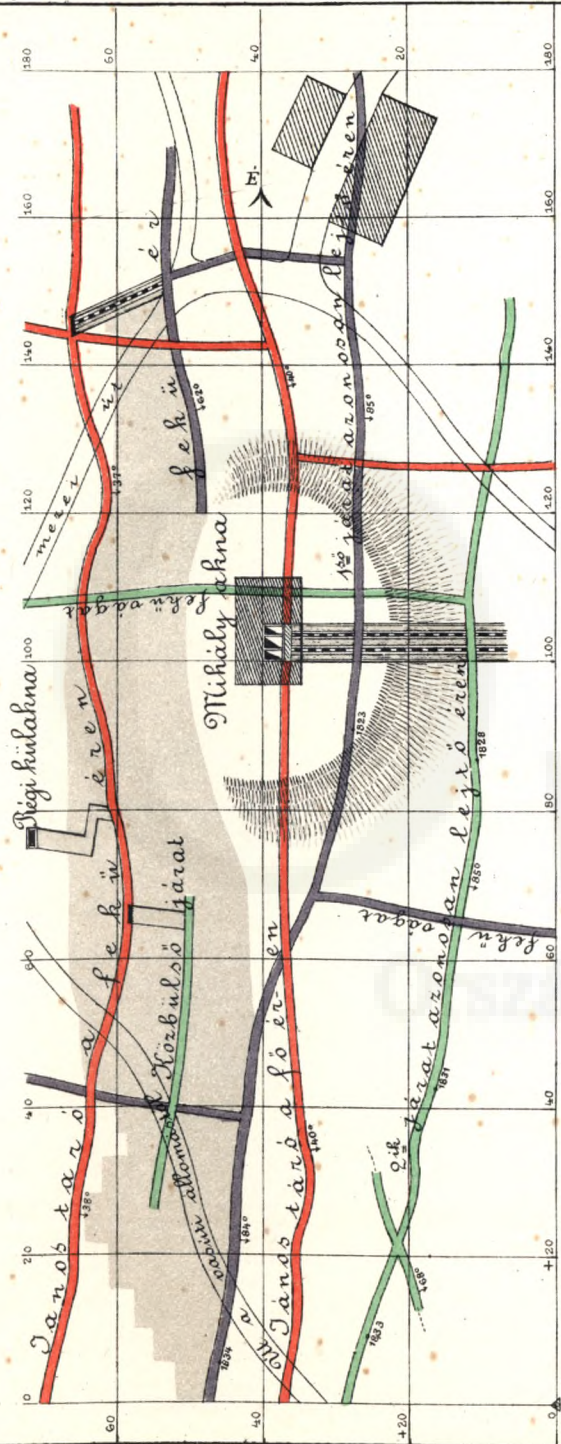

Ércbányák részletes térképeken.

164. ábra.



163 ábra

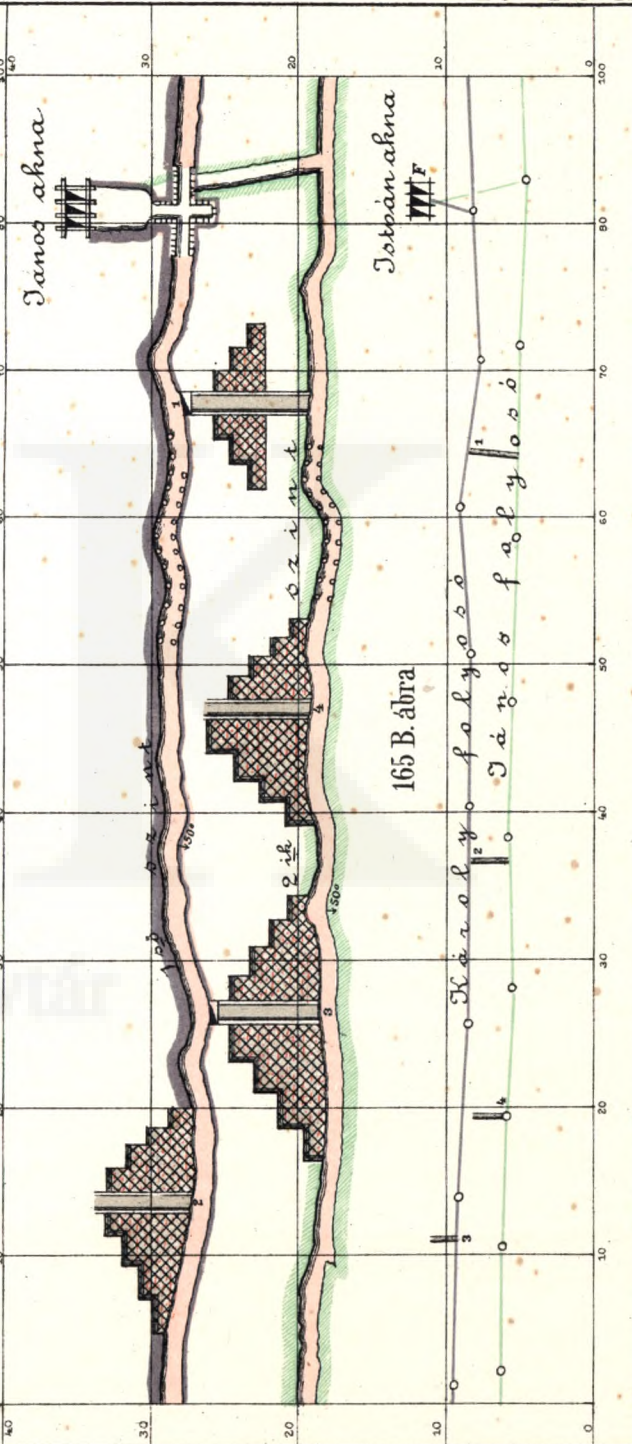

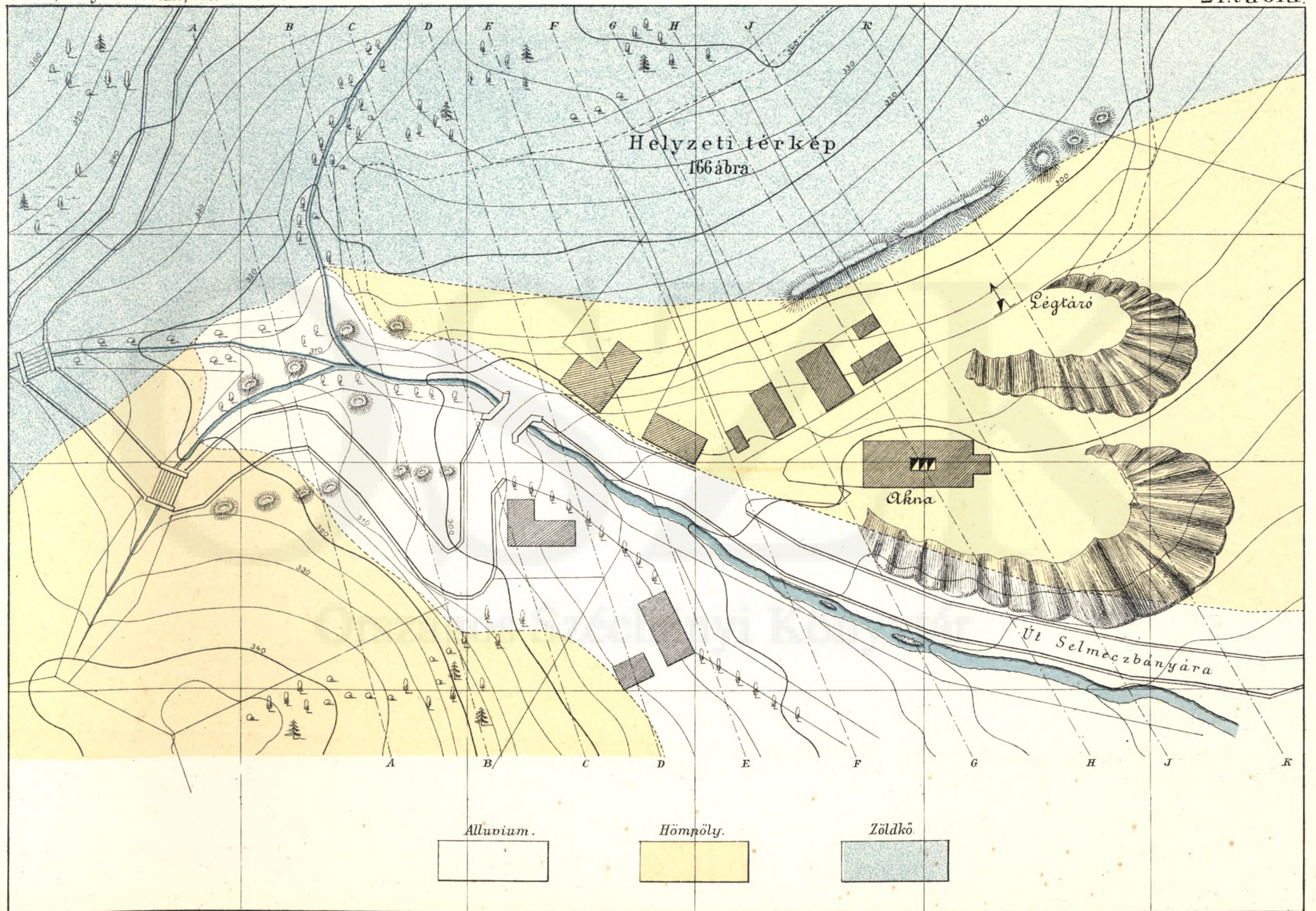

Átnézeti térkép
167. ábra.

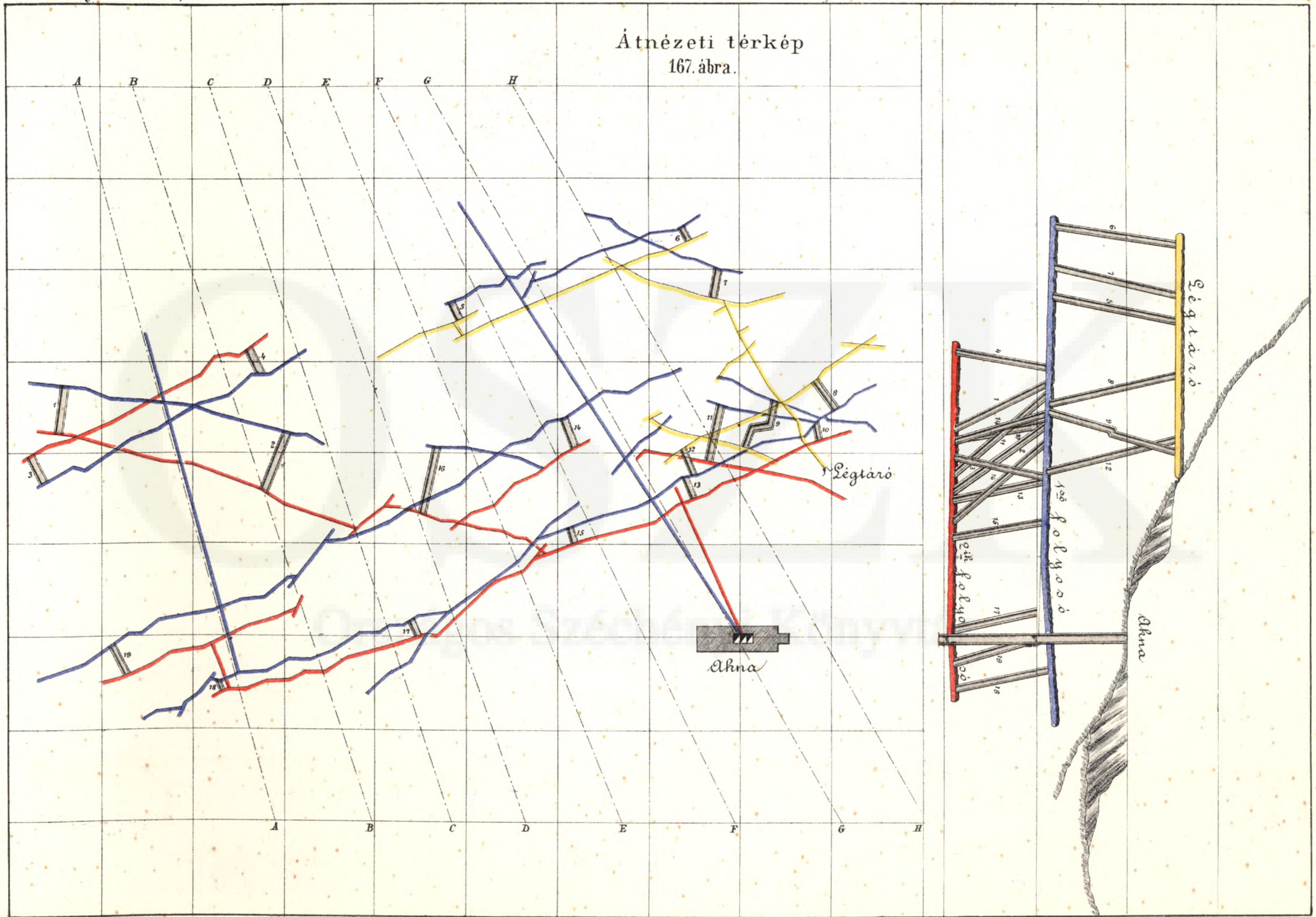

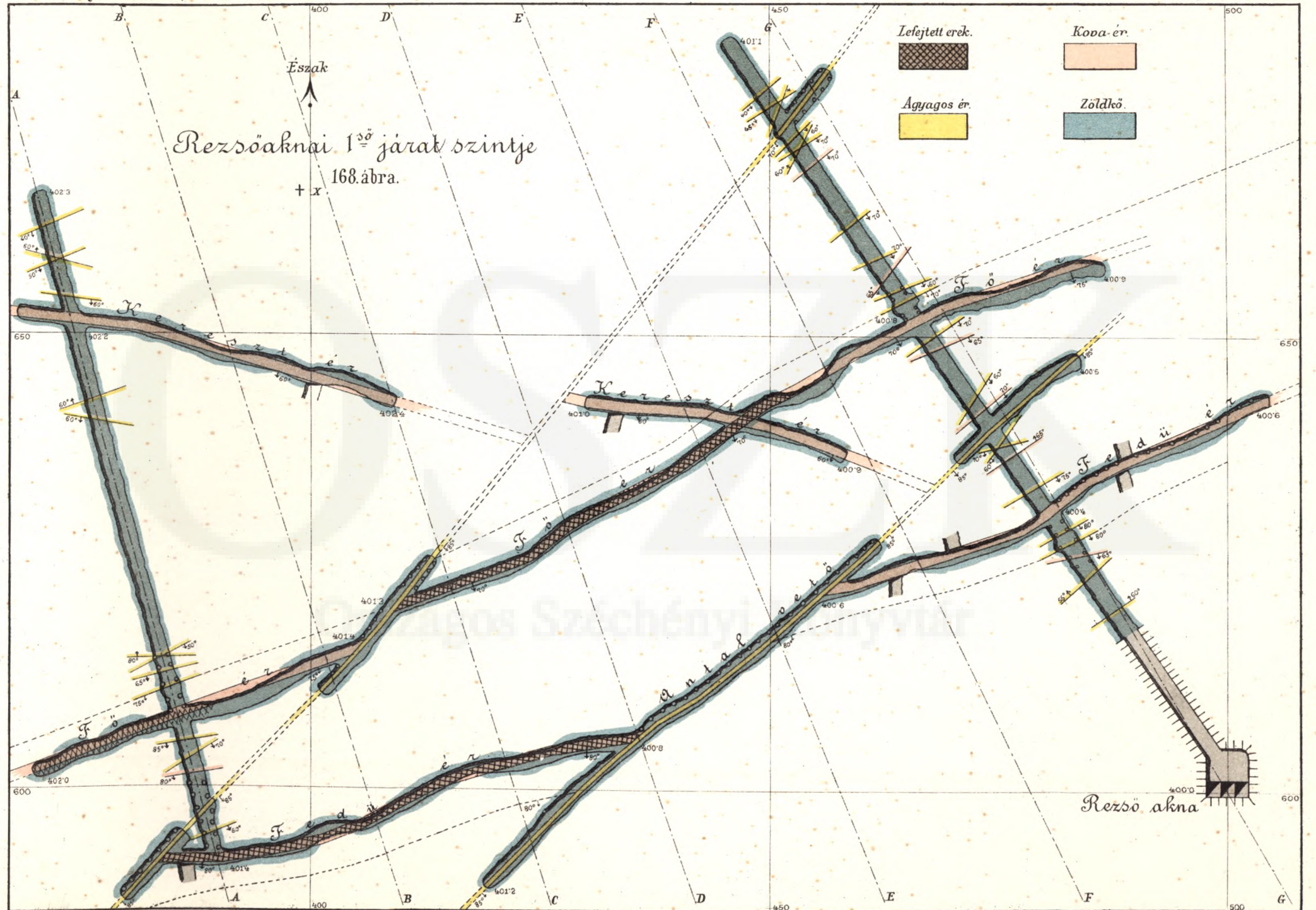

Szeloény A.
169. ábra.

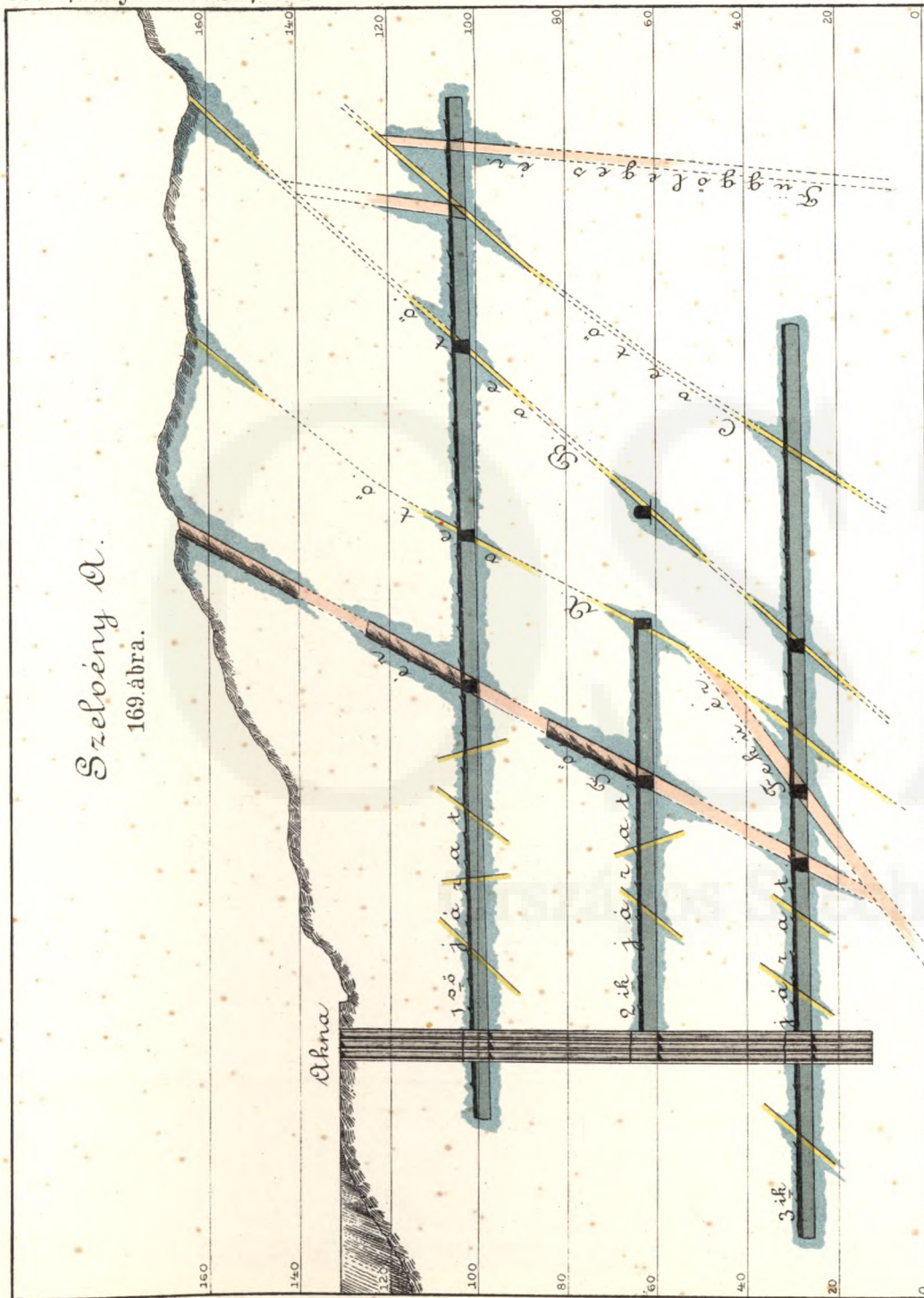

Fejtési térkép a főtélen.
170. ábra.

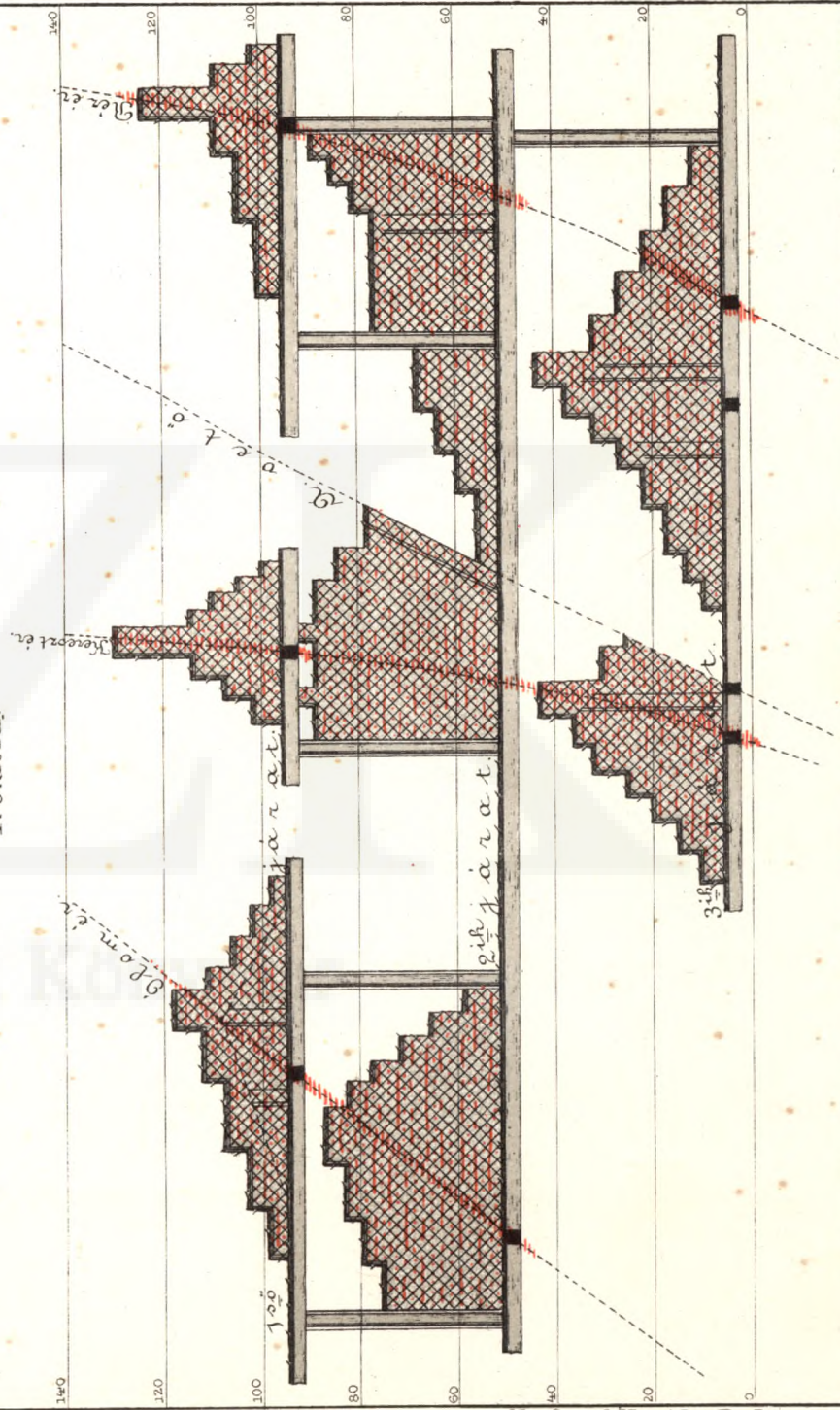

Magyar szénbánya alaprajza

171. ábra.

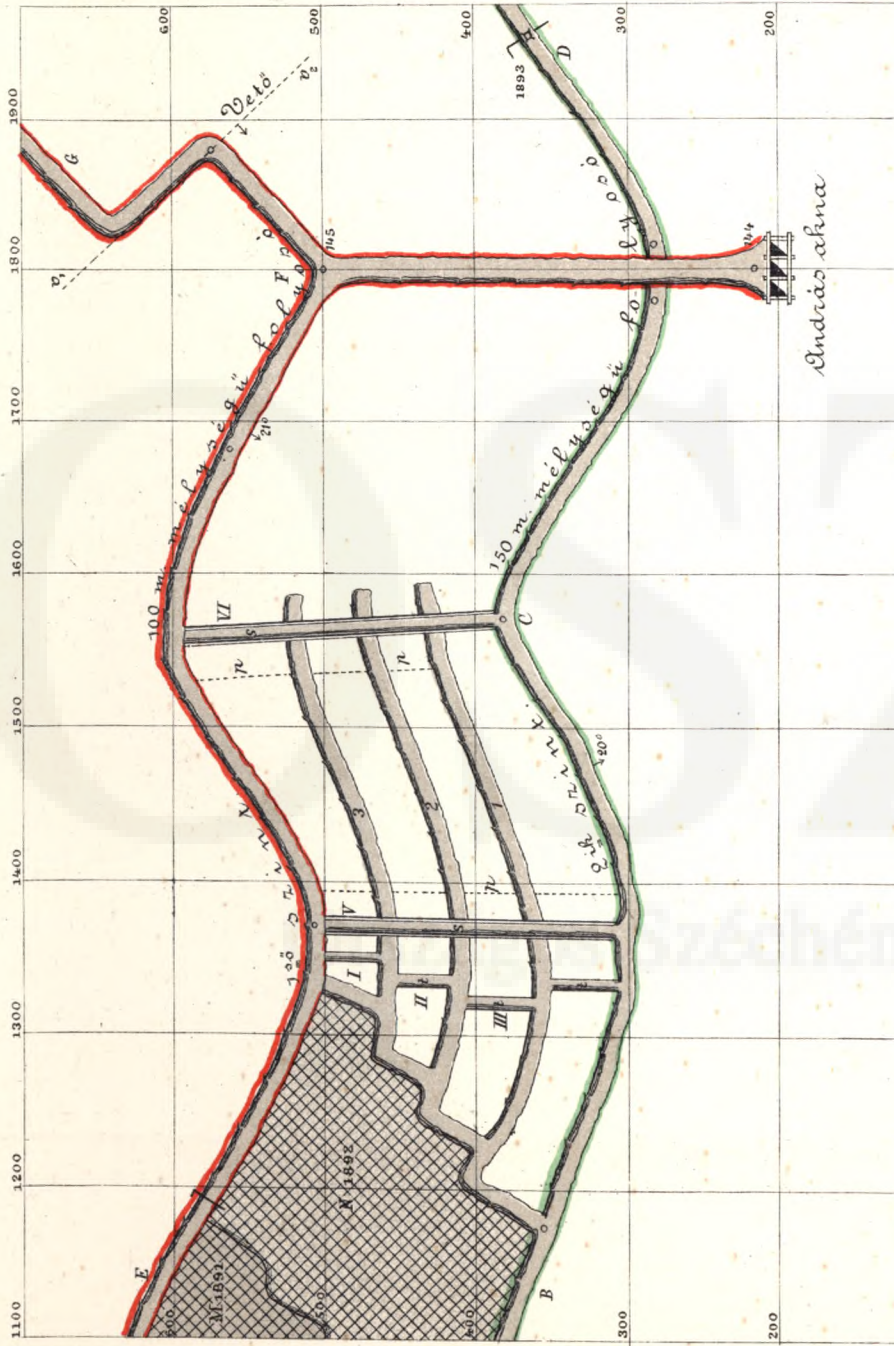

Szászországi szénbánya alaprajza.

172. ábra.

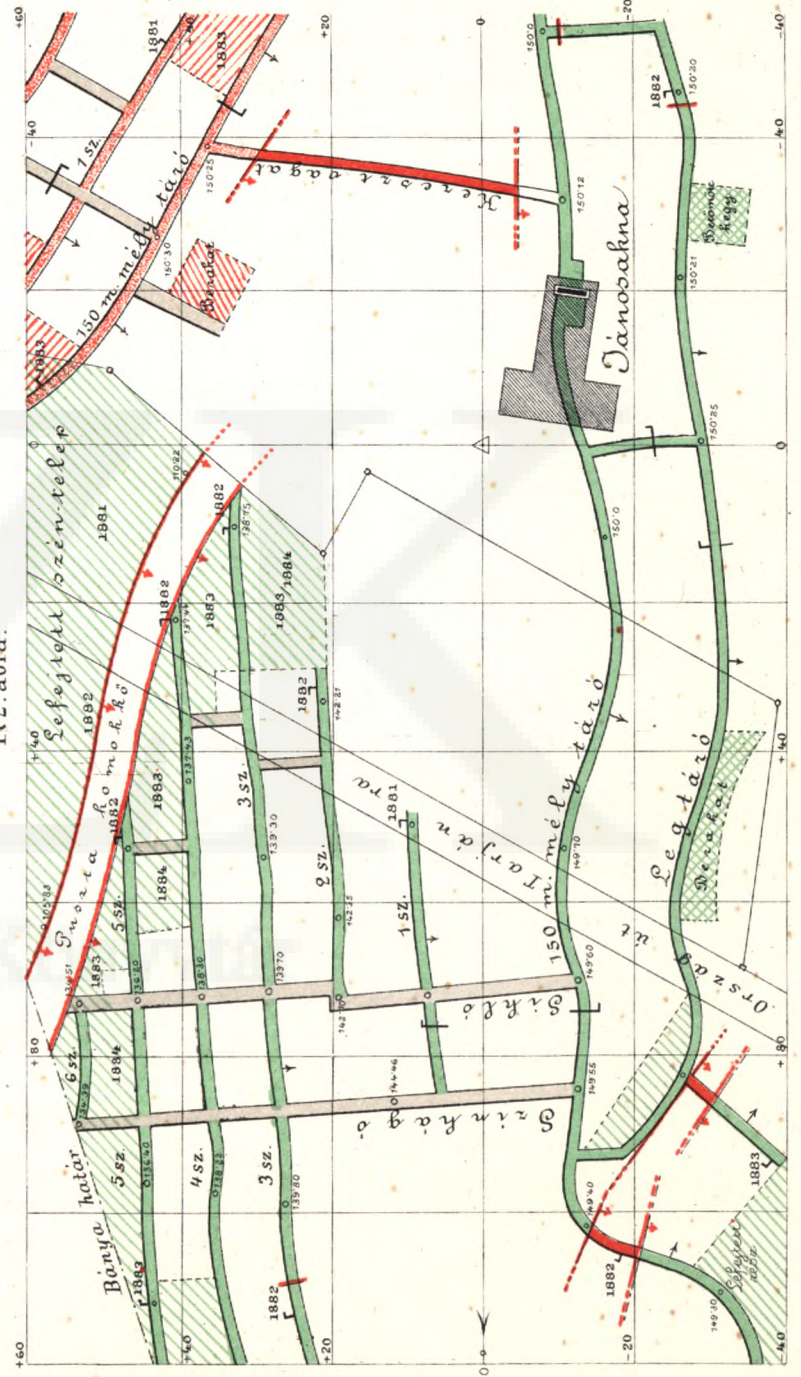

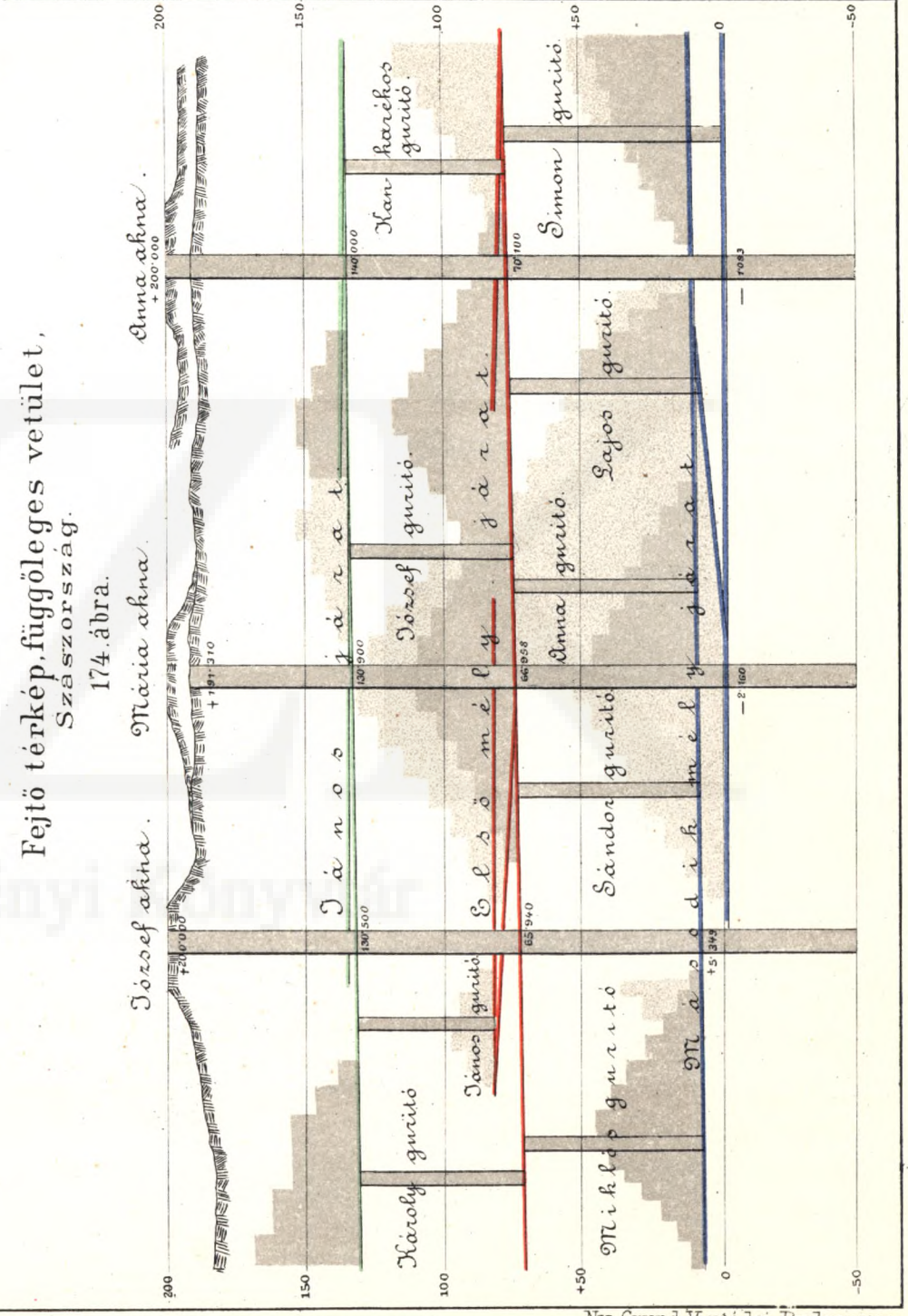
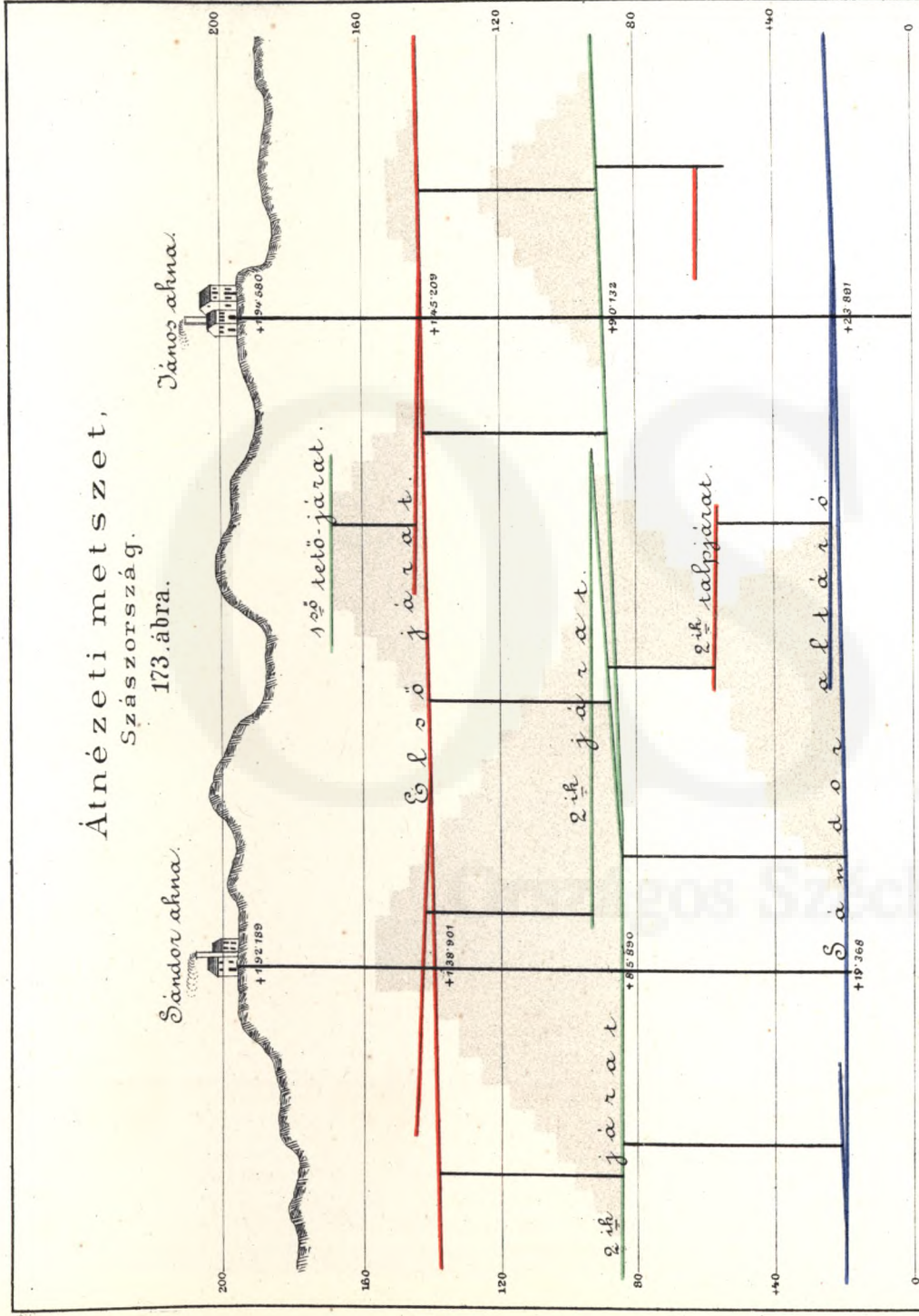

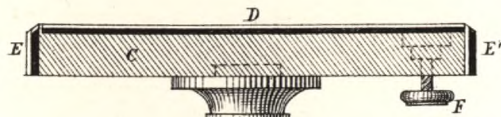

175. ábra.

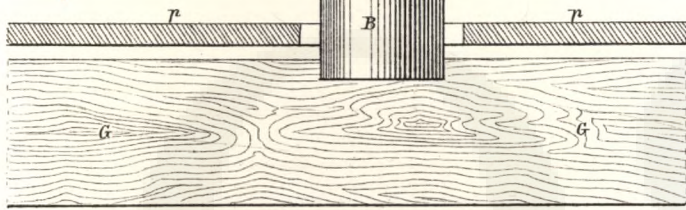

176. ábra.

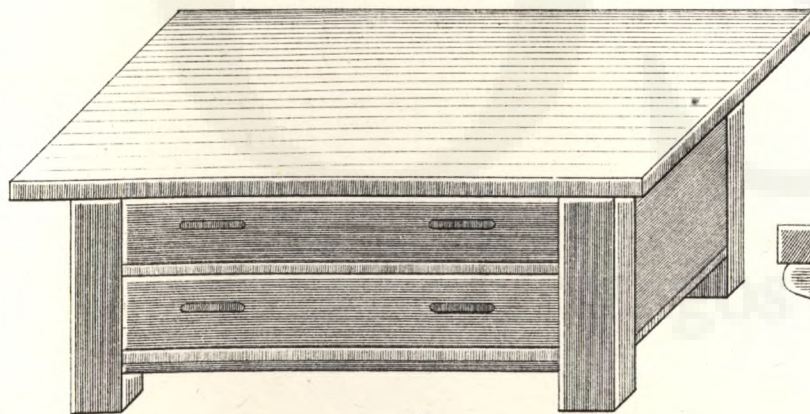

177. ábra.

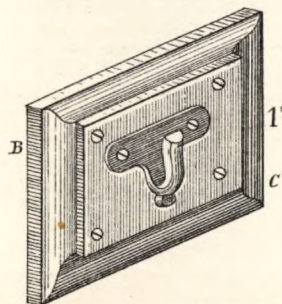

178. ábra.

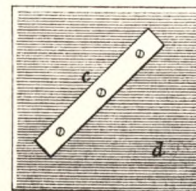

179. ábra.

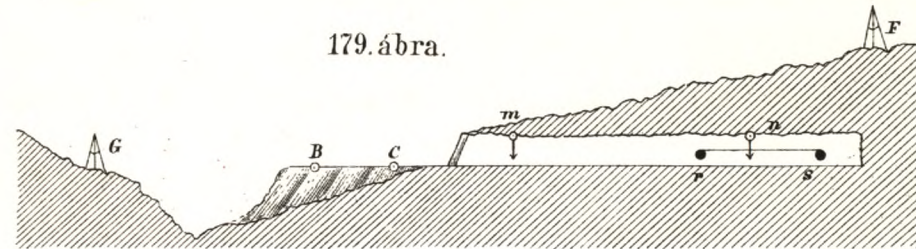

180. ábra.

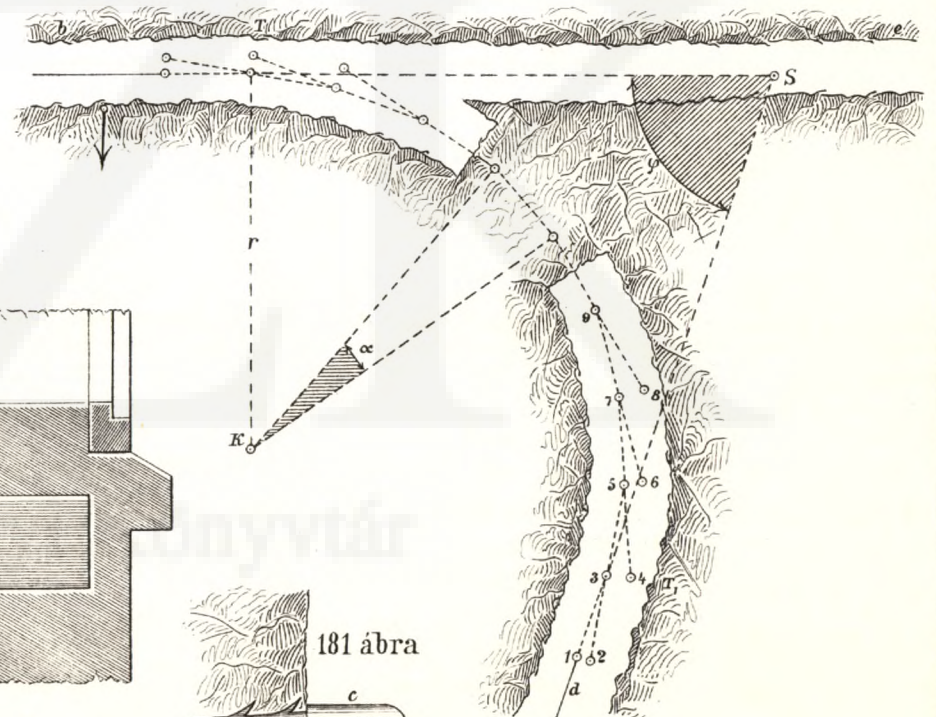

181. ábra.

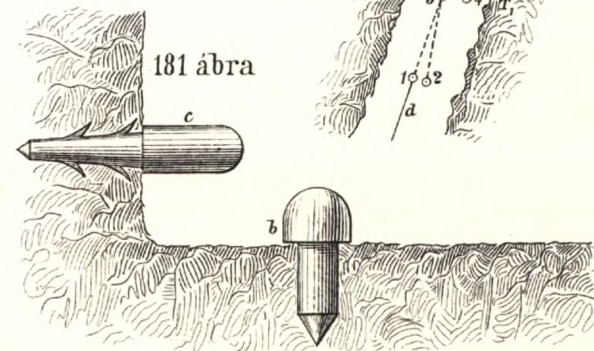

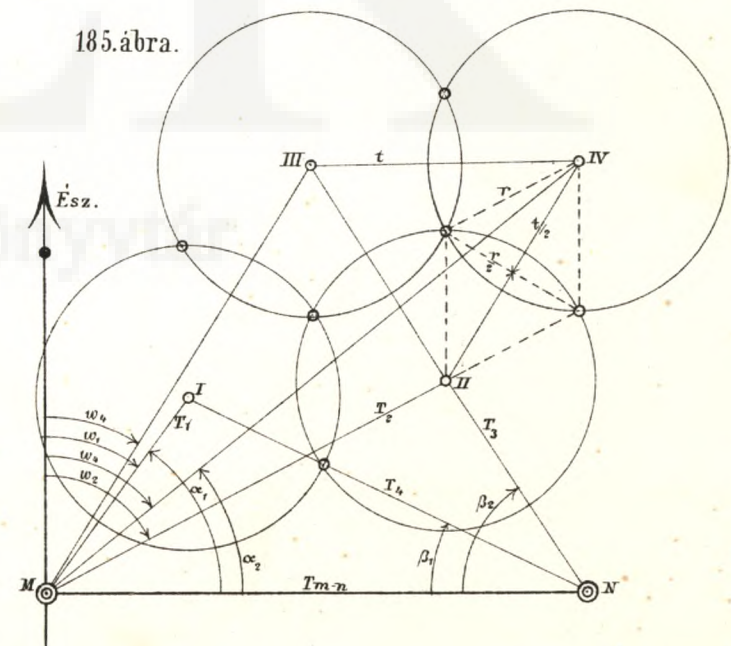
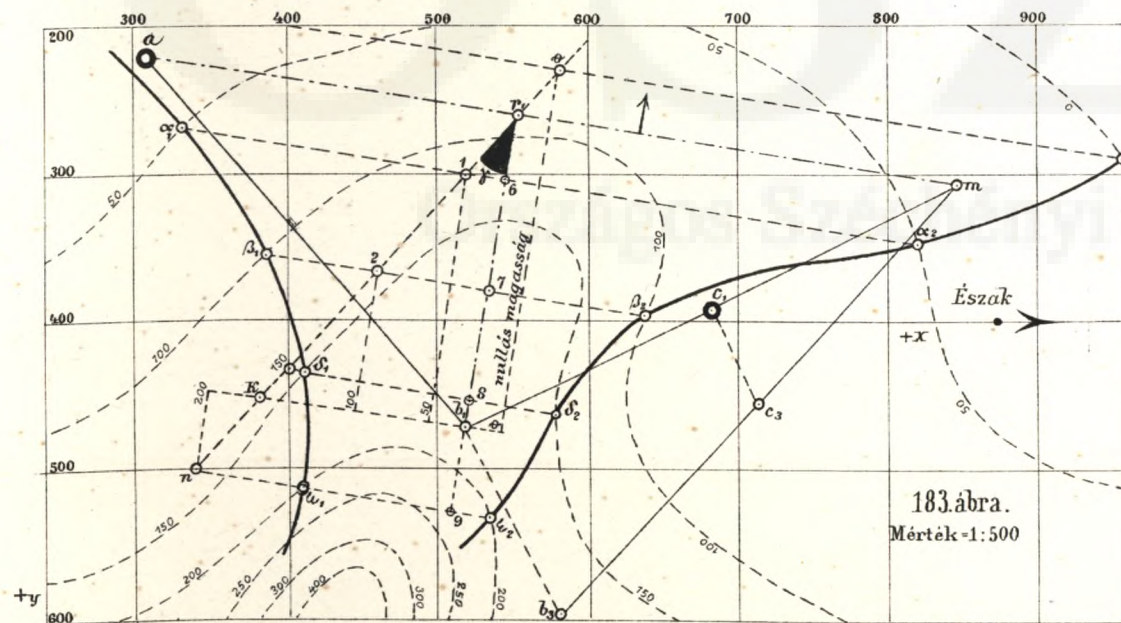
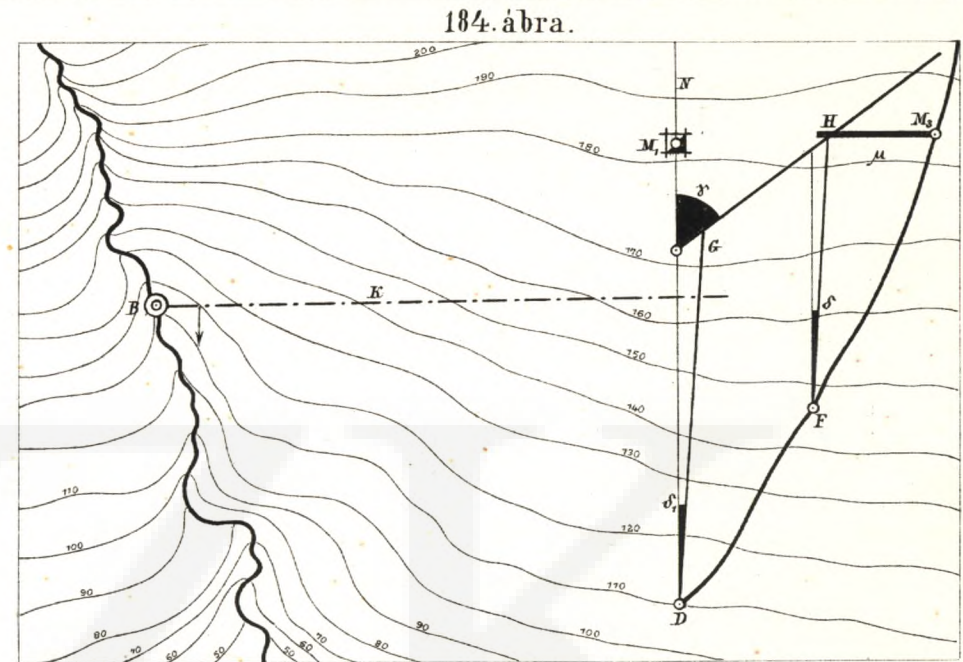
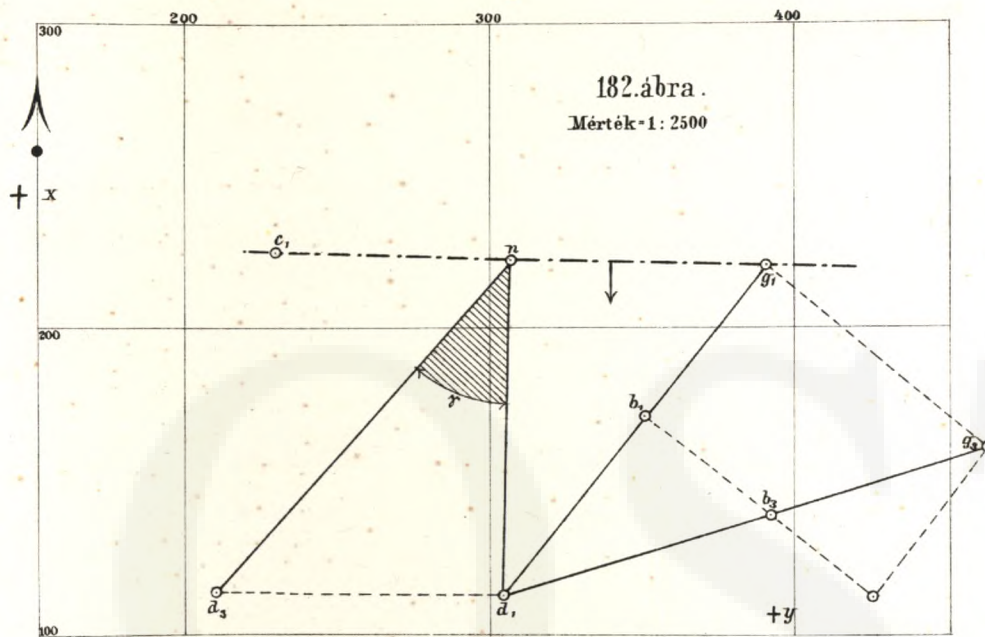

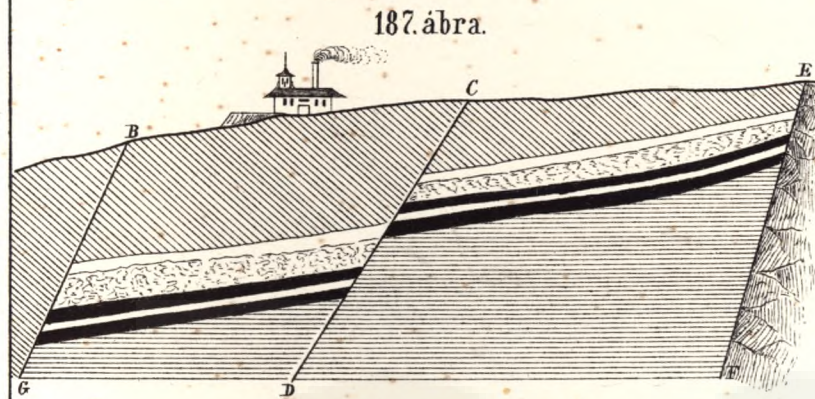

187. ábra.

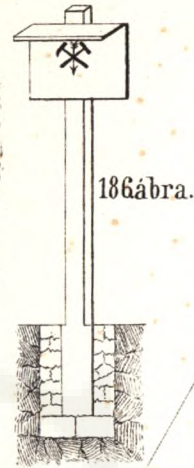

186. ábra.

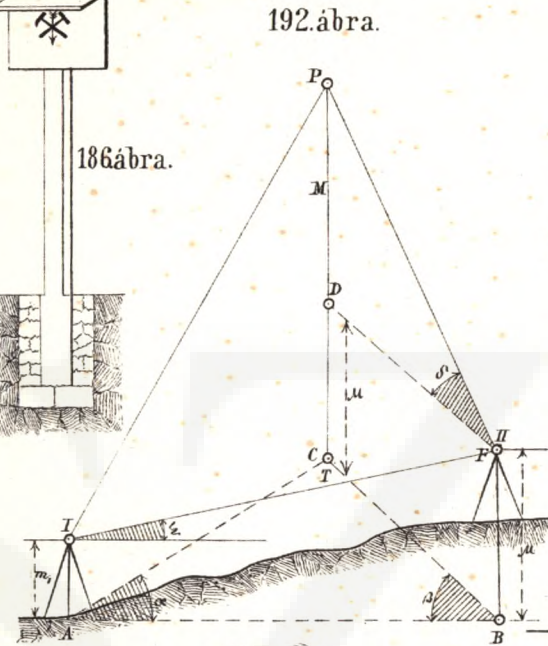

192. ábra.



190. ábra.
K₂X. metszet.

oK₁

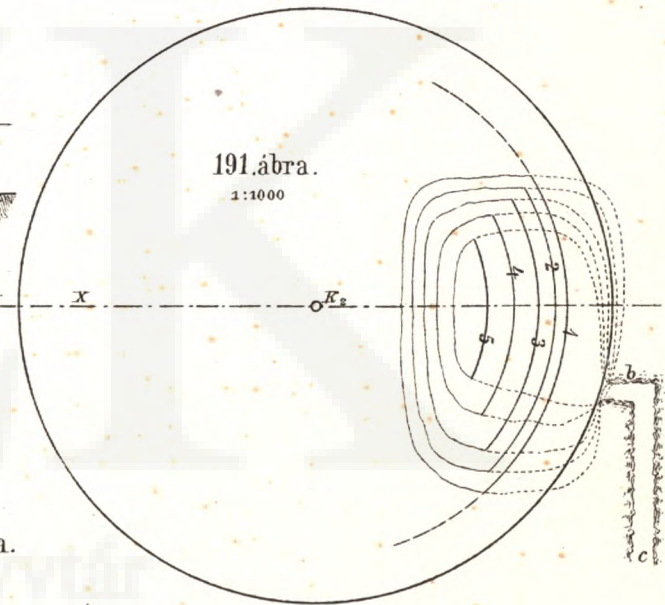

191. ábra.
1:1000

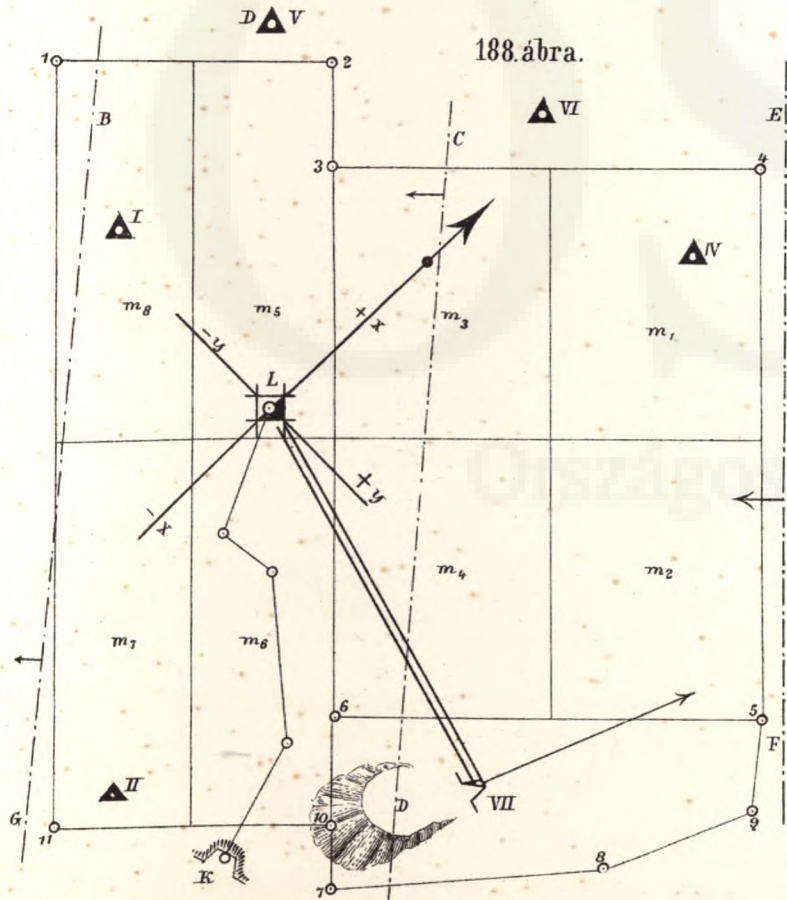

188. ábra.

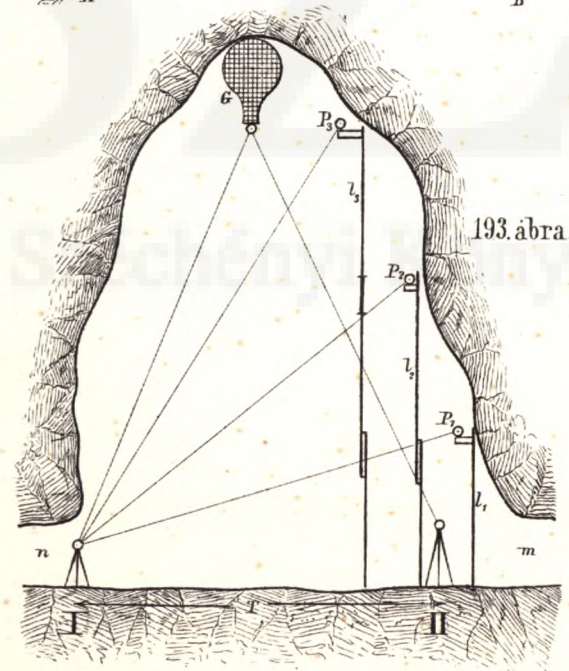

193. ábra.

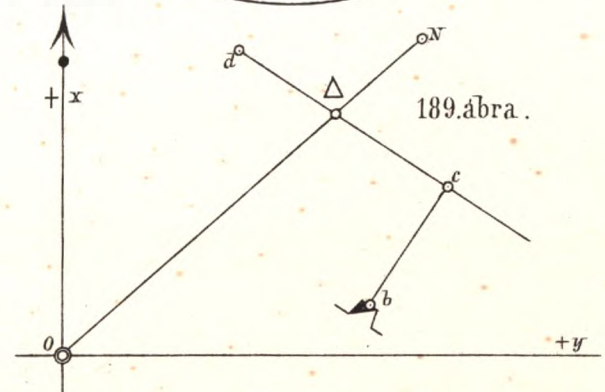

189. ábra.

194. ábra.

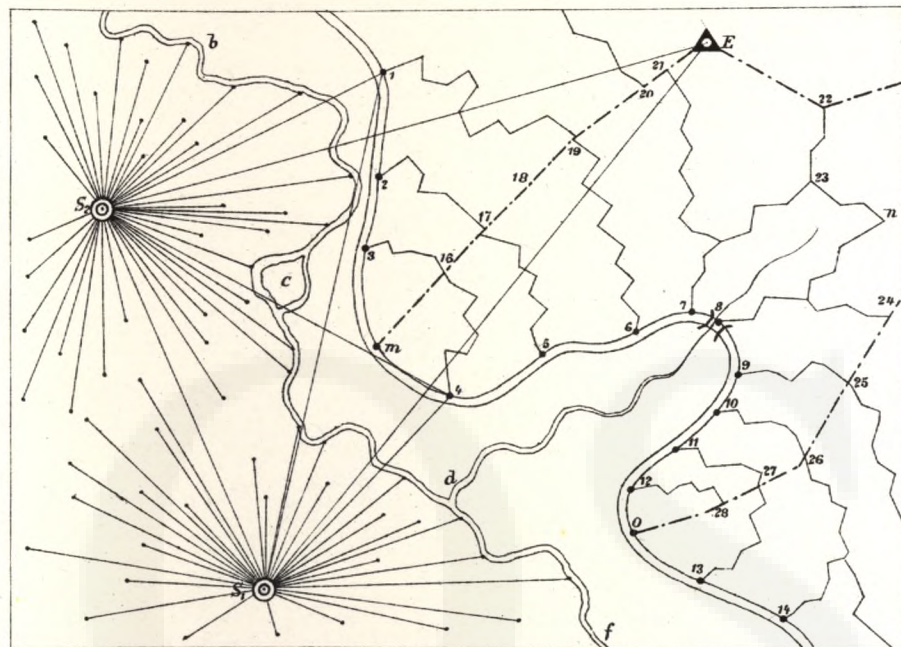

197. ábra.

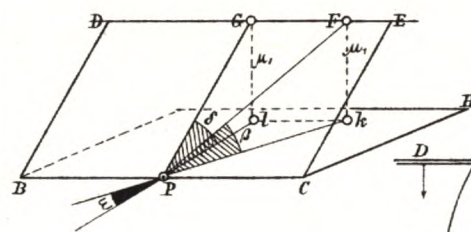

198. ábra.

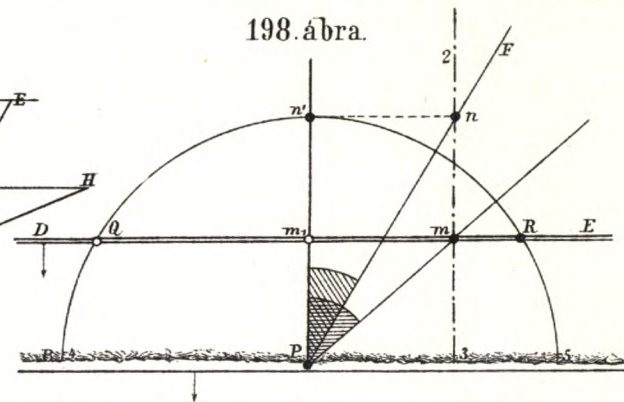

195. ábra.

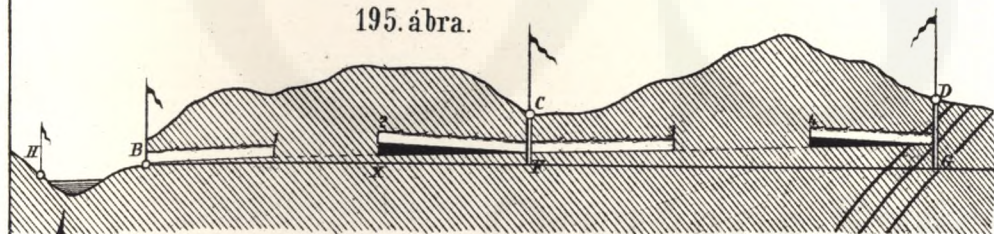

199. ábra.

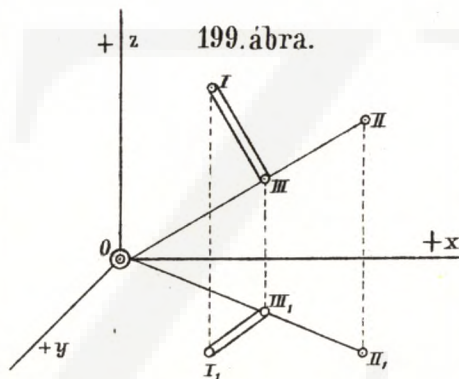

200. ábra.

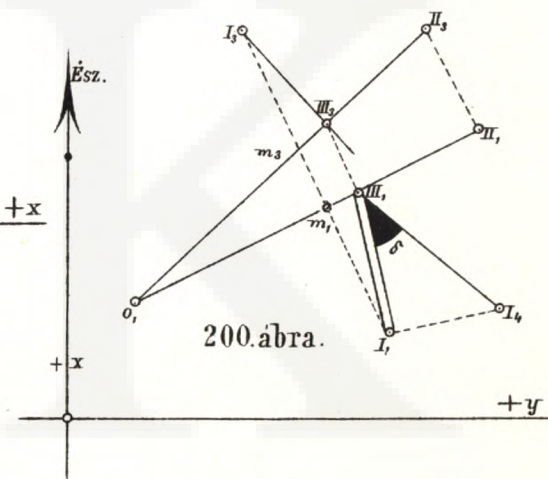

196. ábra.

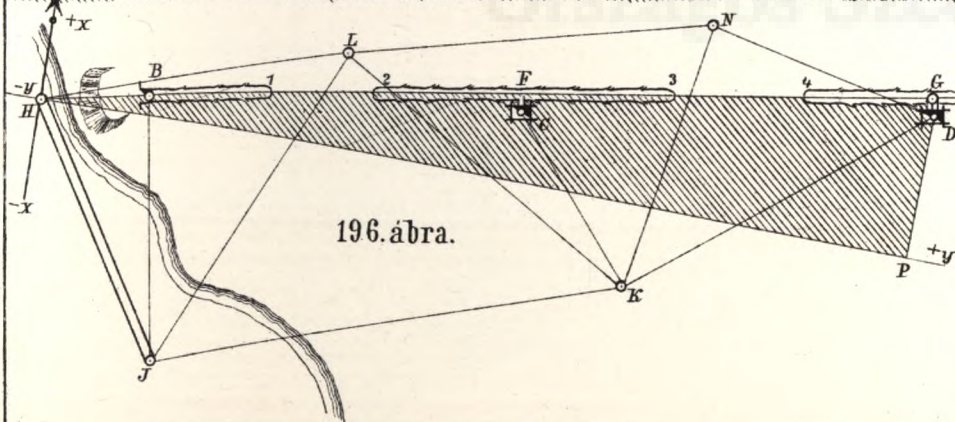

201. ábra.

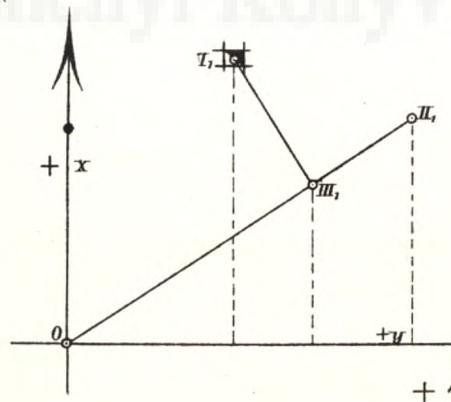

202. ábra.

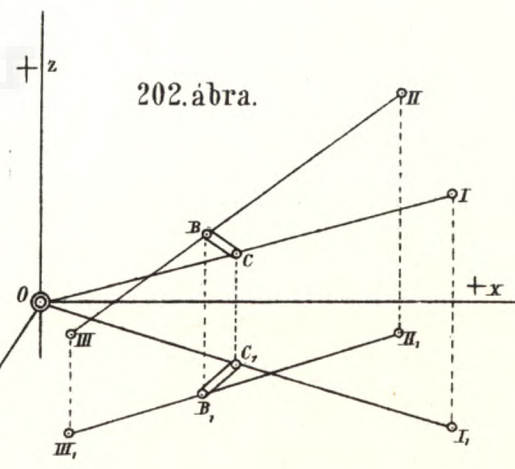

207. ábra.

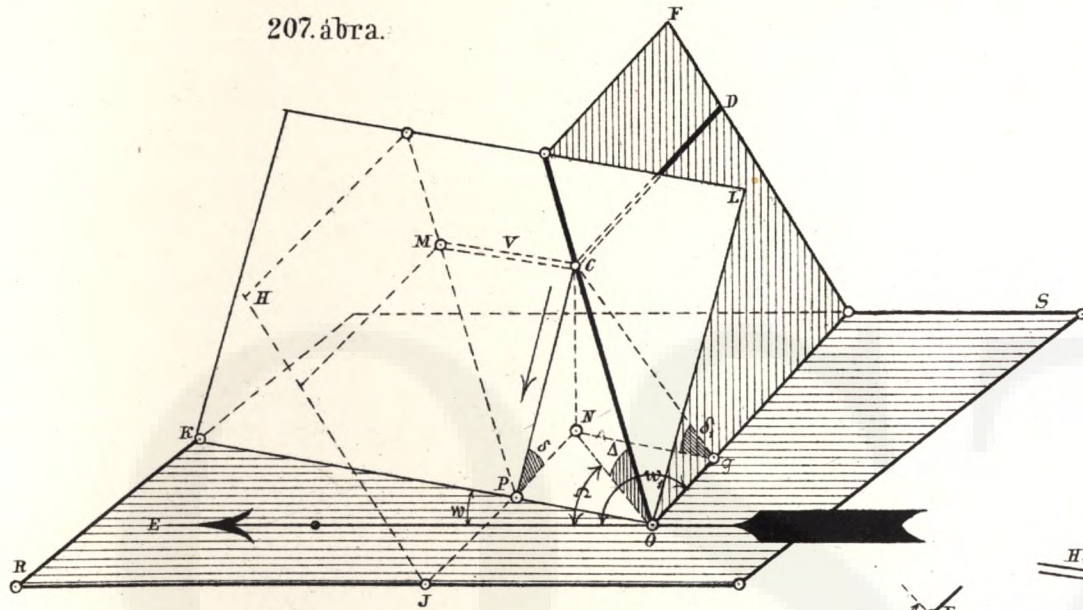

209. ábra.

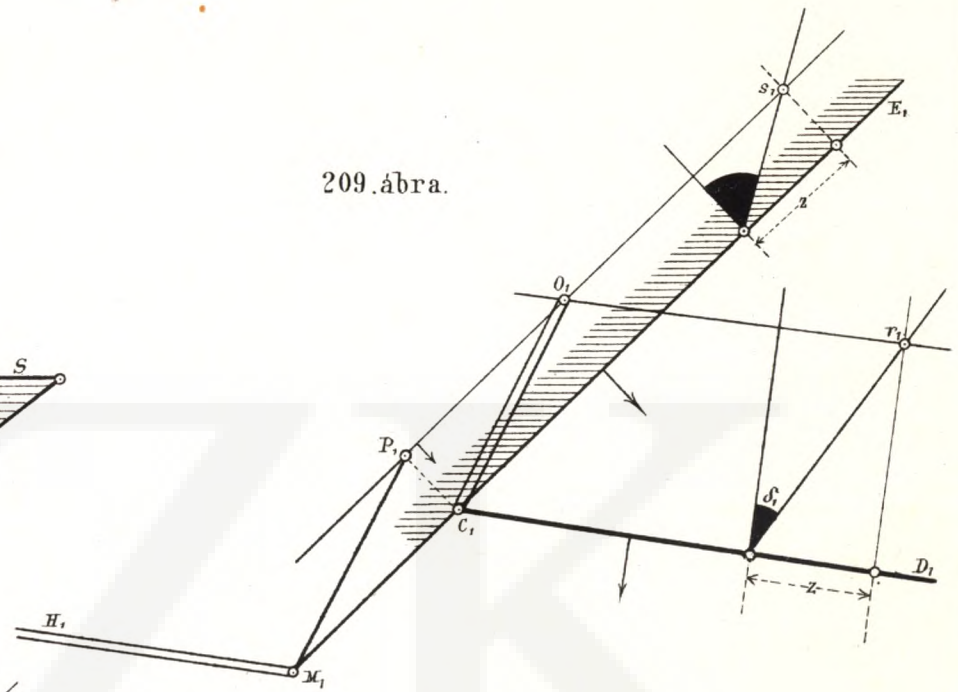

208. ábra.

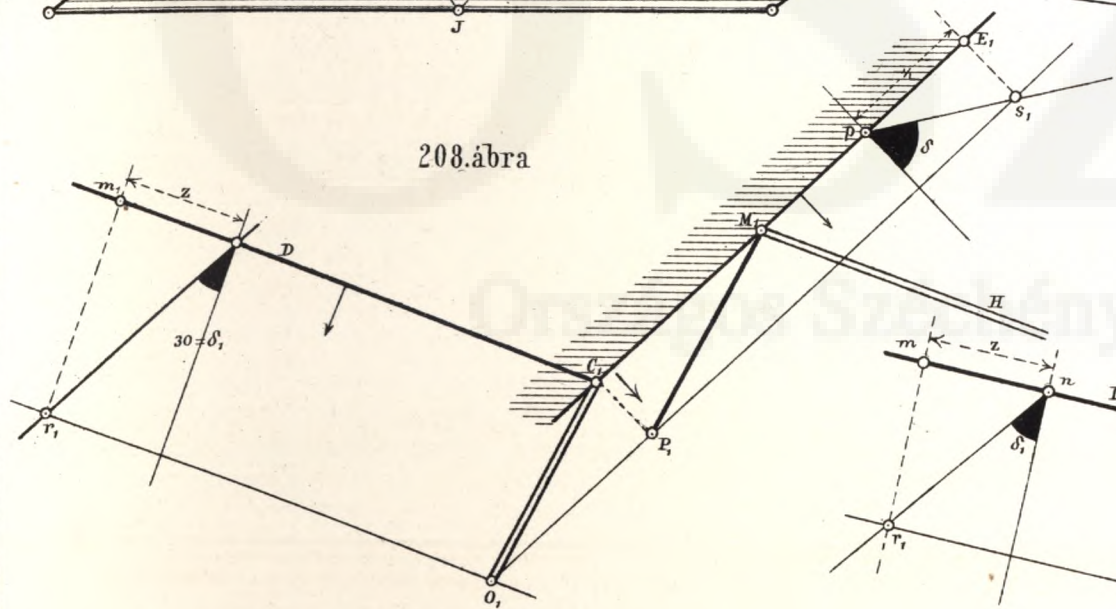

210. ábra.

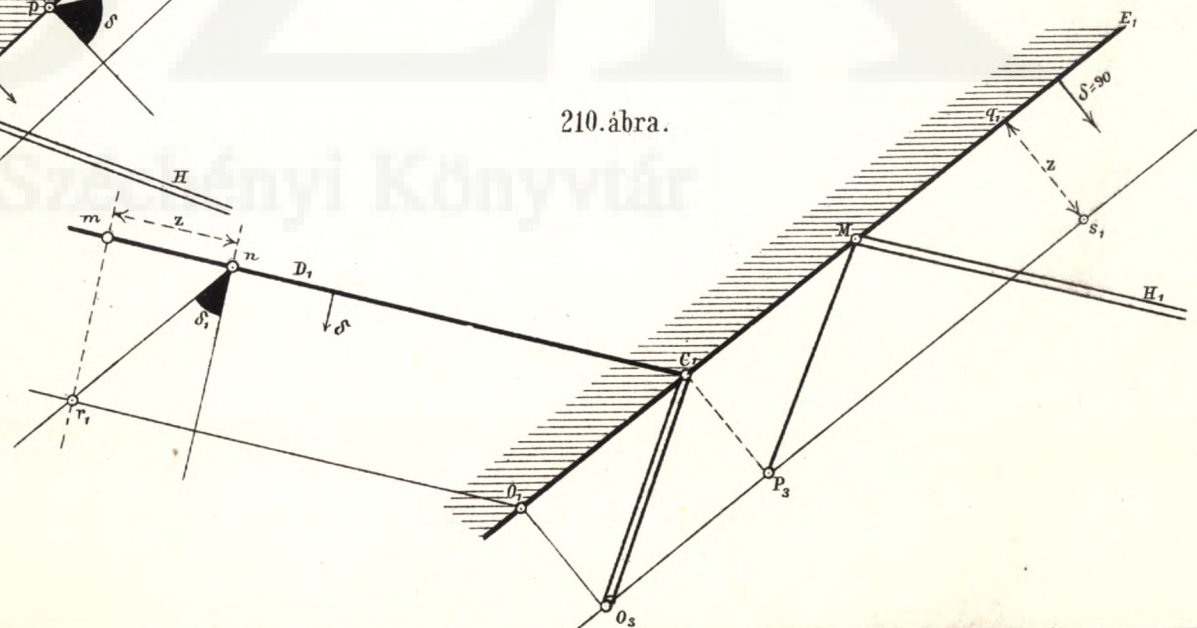

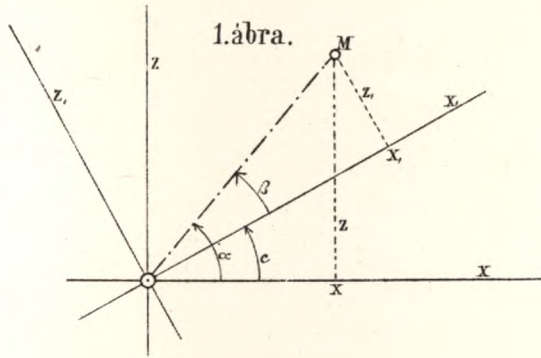

1. ábra.

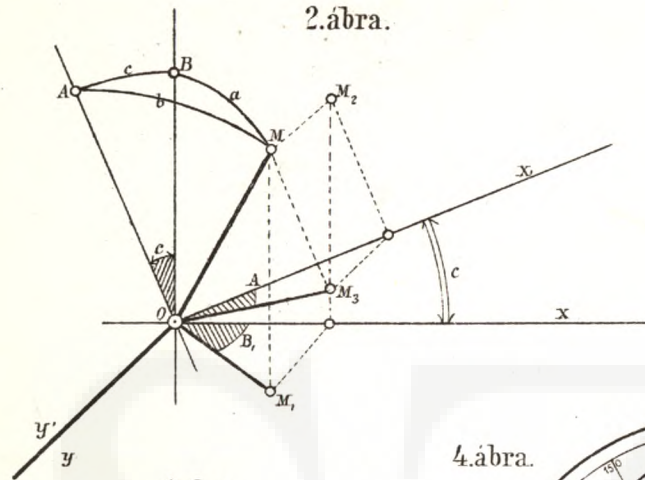

2. ábra.

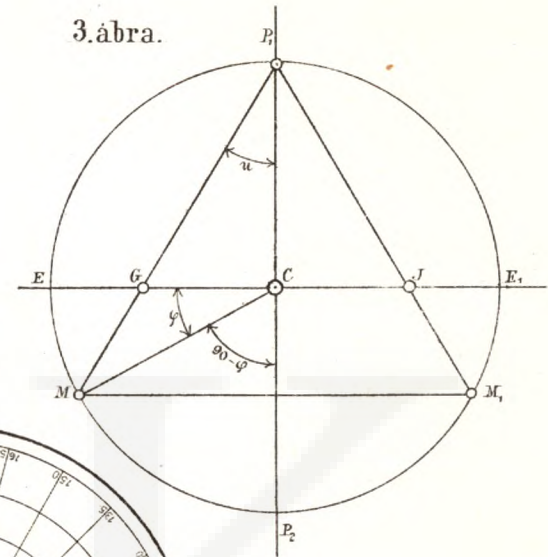

3. ábra.

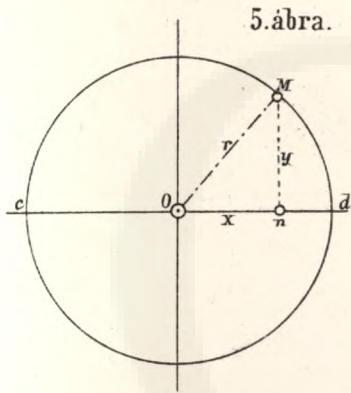

5. ábra.

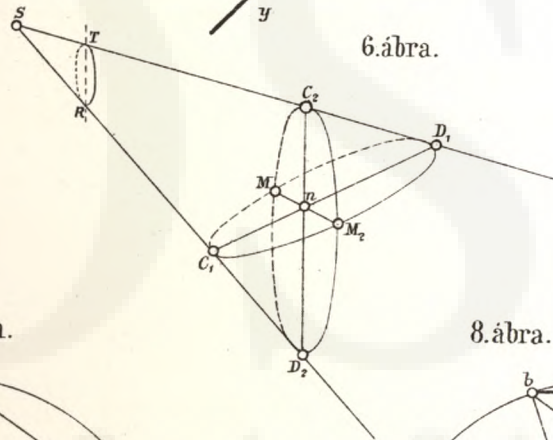

6. ábra.

4. ábra.

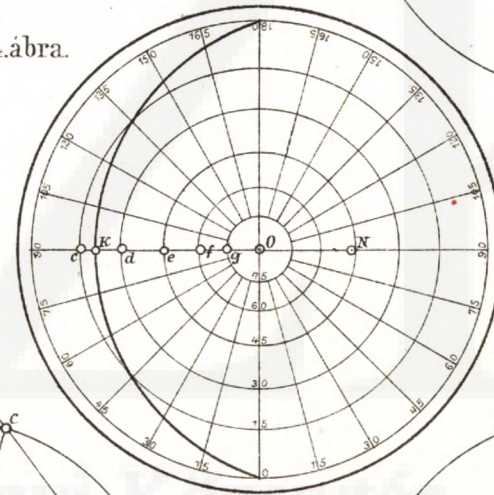

7. ábra.

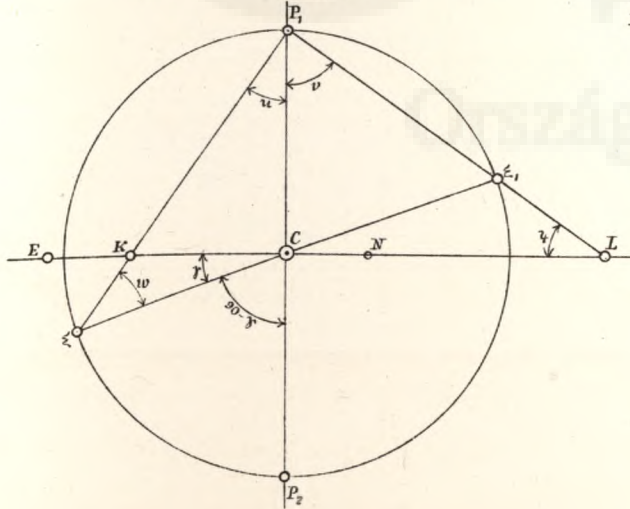

8. ábra.

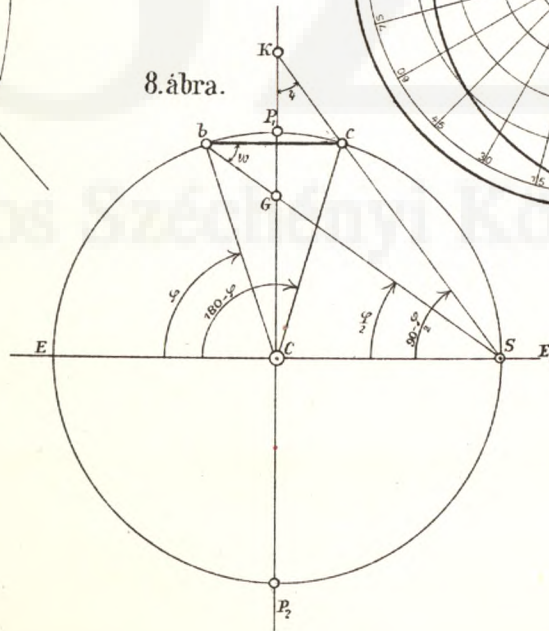

9. ábra.

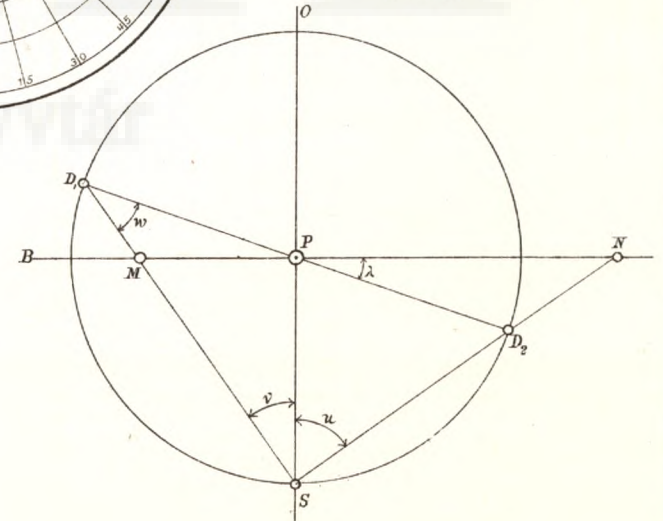

10. ábra.

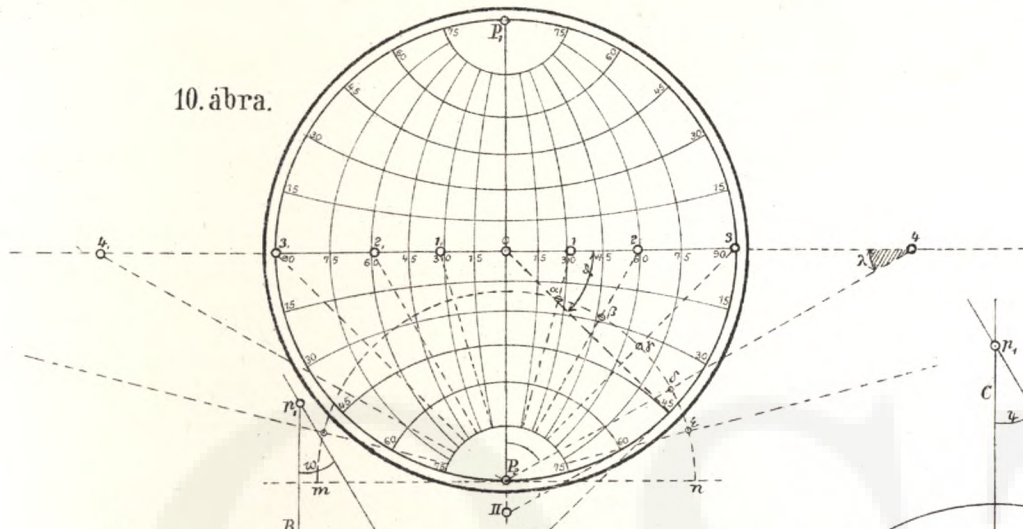

13. ábra.

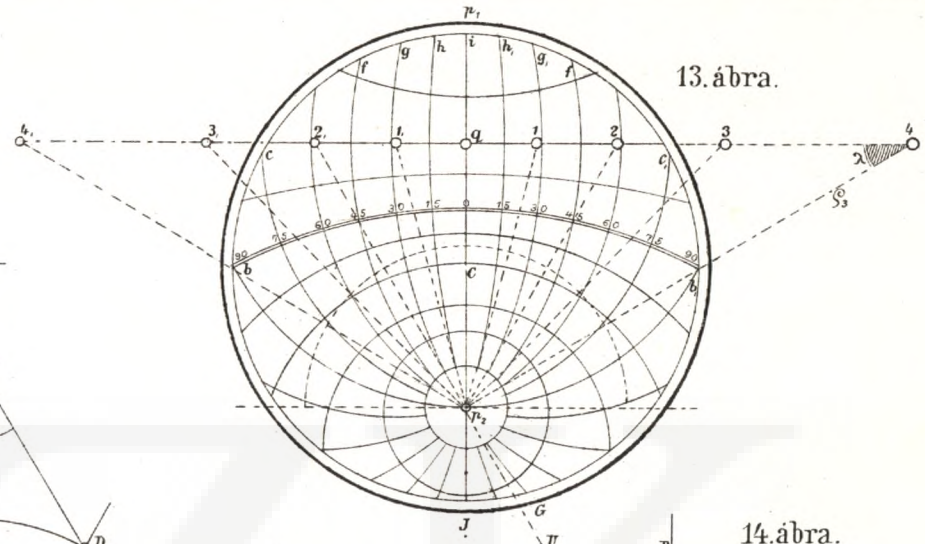

11. ábra.

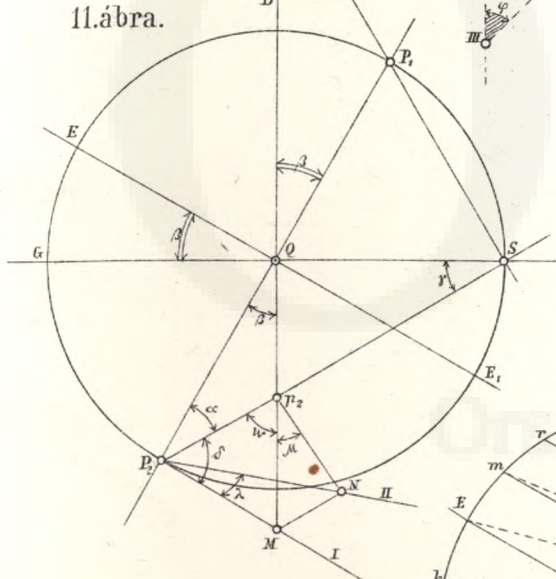

12. ábra.

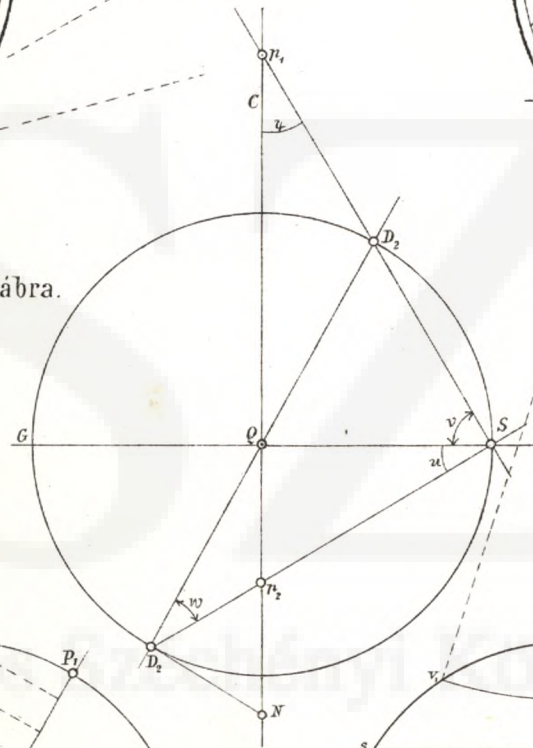

14. ábra.

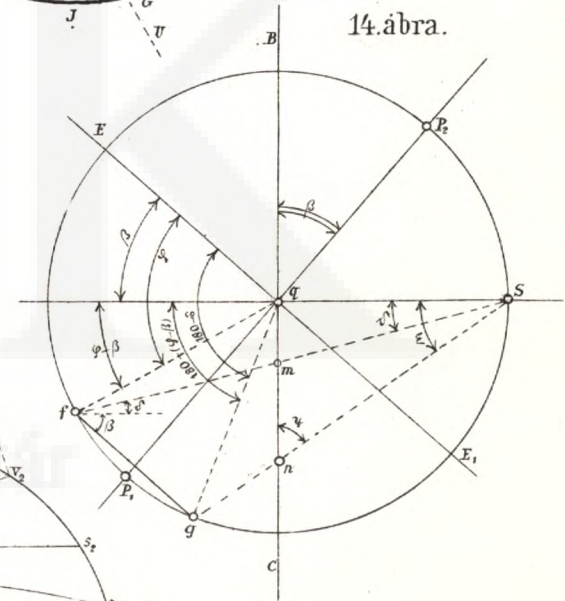

15. ábra.

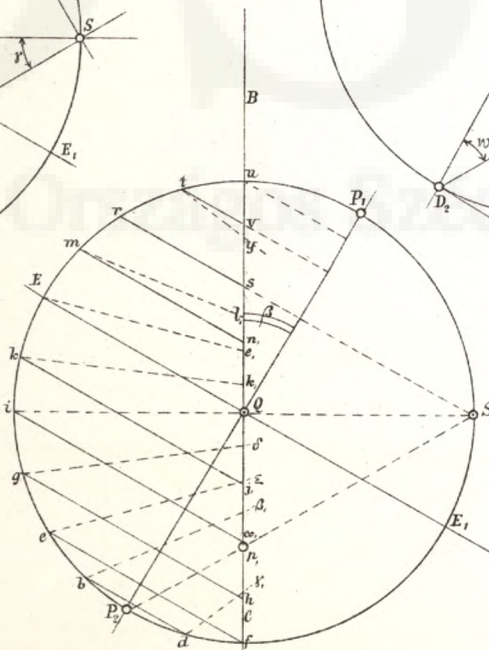

16. ábra.

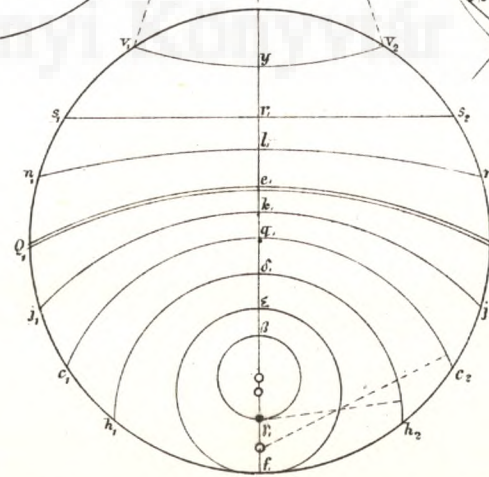

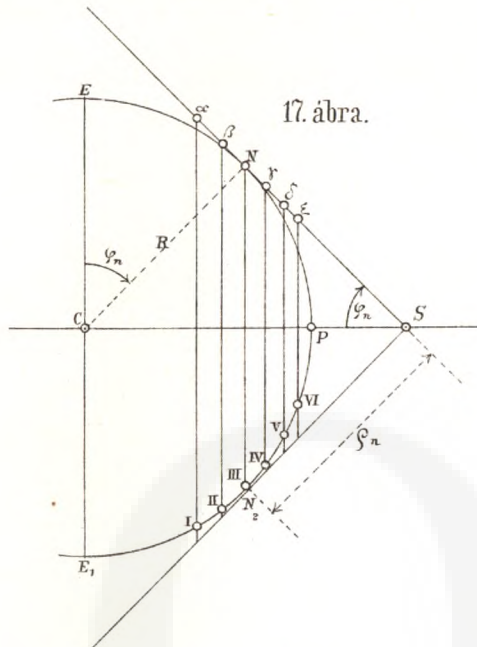

17. ábra.

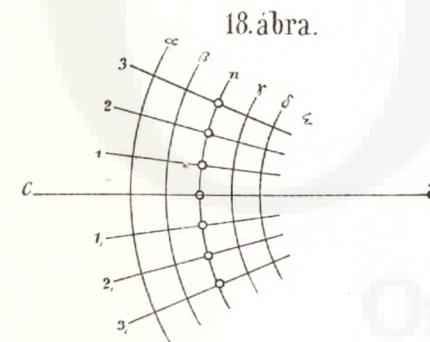

18. ábra.

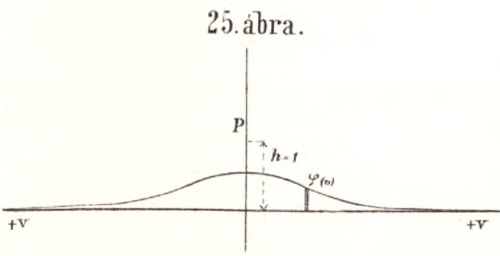

25. ábra.

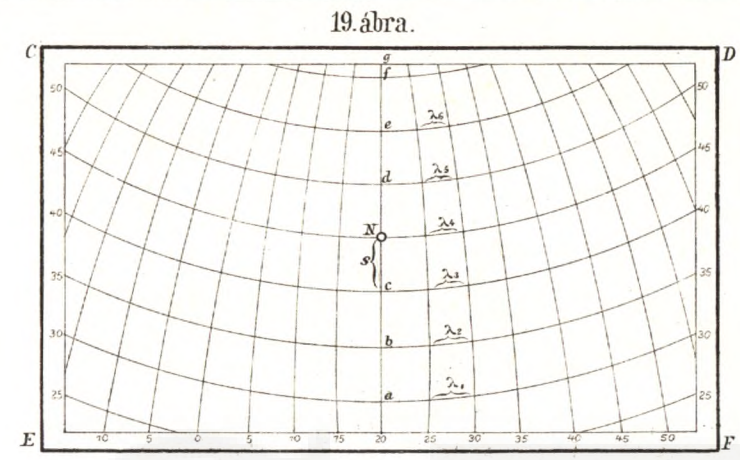

19. ábra.

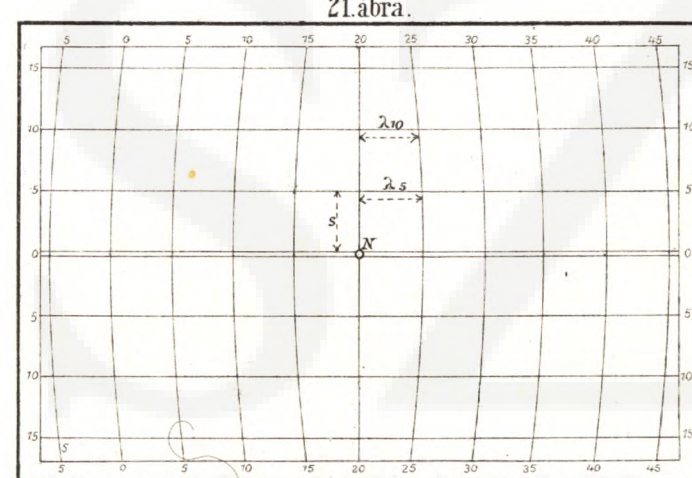

21. ábra.

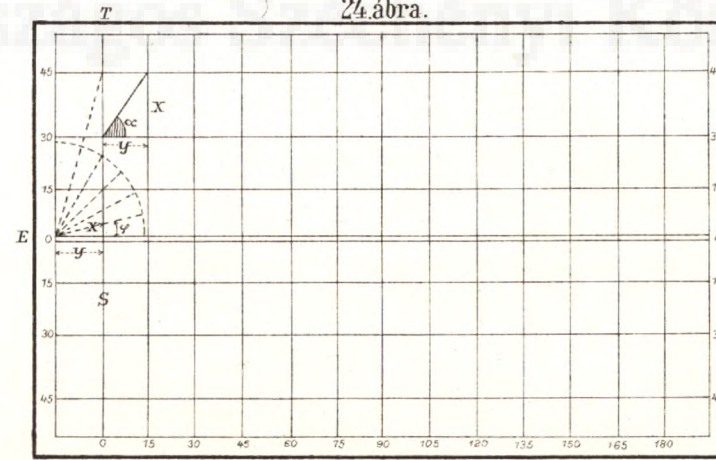

24. ábra.

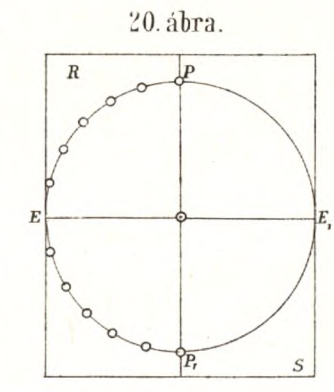

20. ábra.

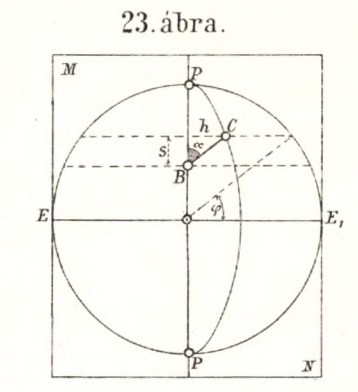

23. ábra.

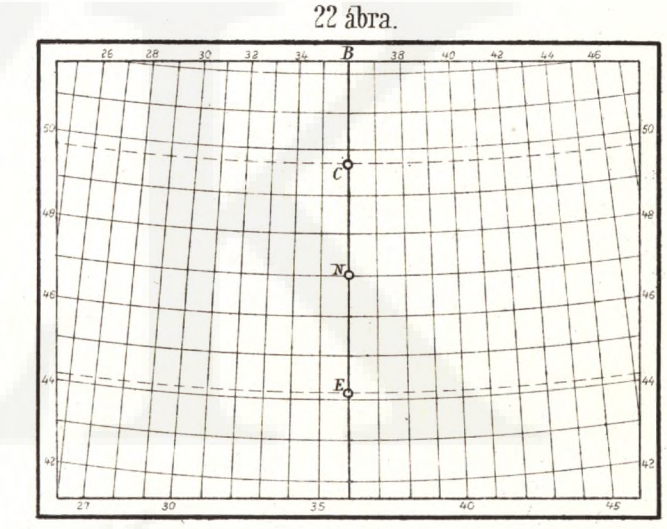

22. ábra.

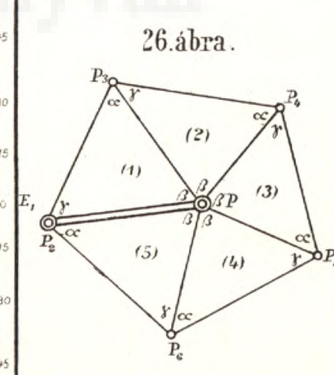

26. ábra.

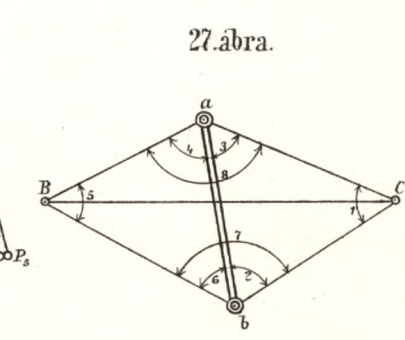

27. ábra.

28.ábra.

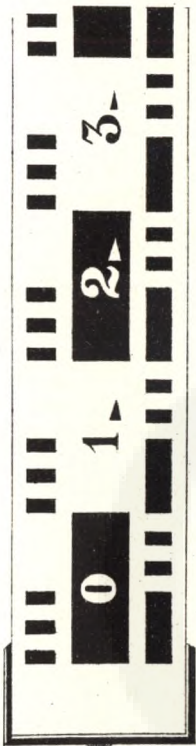

29.ábra.

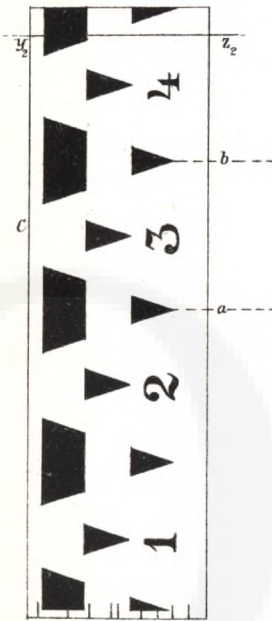

30.ábra.

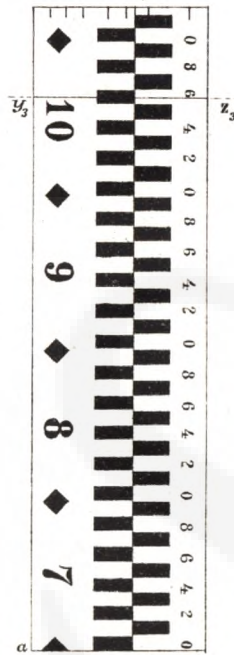

31.ábra.

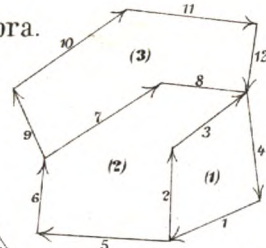

33.ábra.

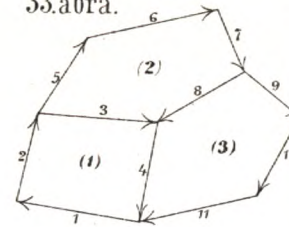

34.ábra.

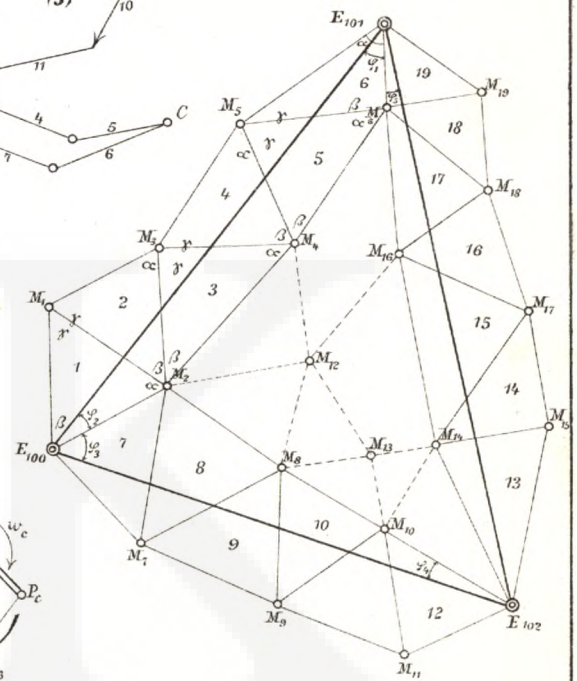

35.ábra.

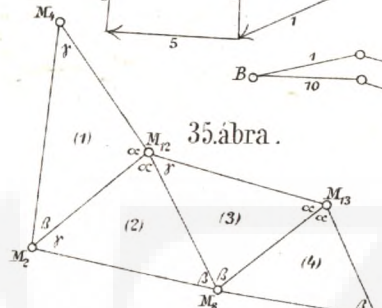

32.ábra

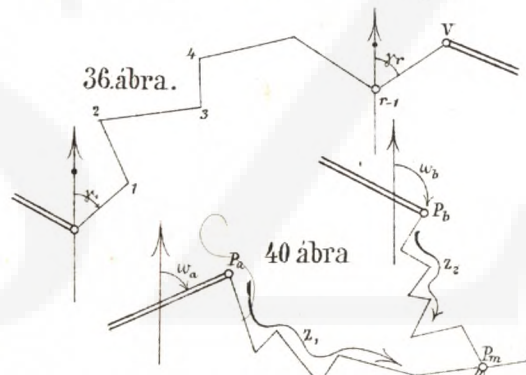

36.ábra.

40. ábra

37.ábra.

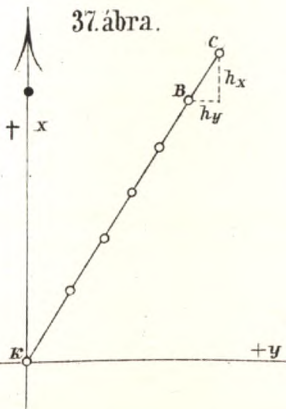

38.ábra.

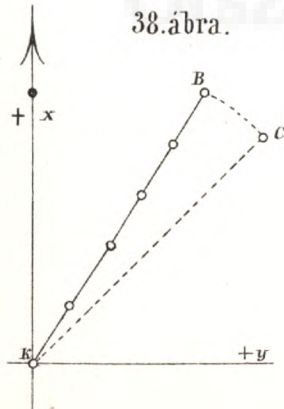

39.ábra.

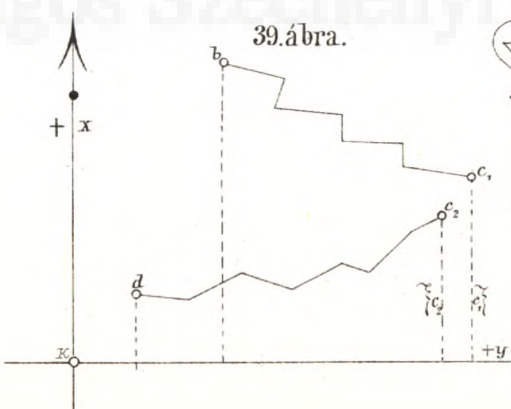

41.ábra.

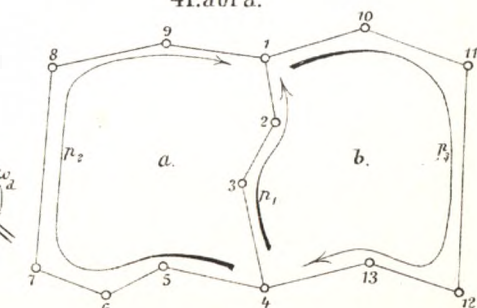

42.ábra.

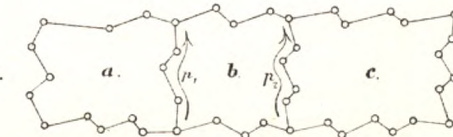

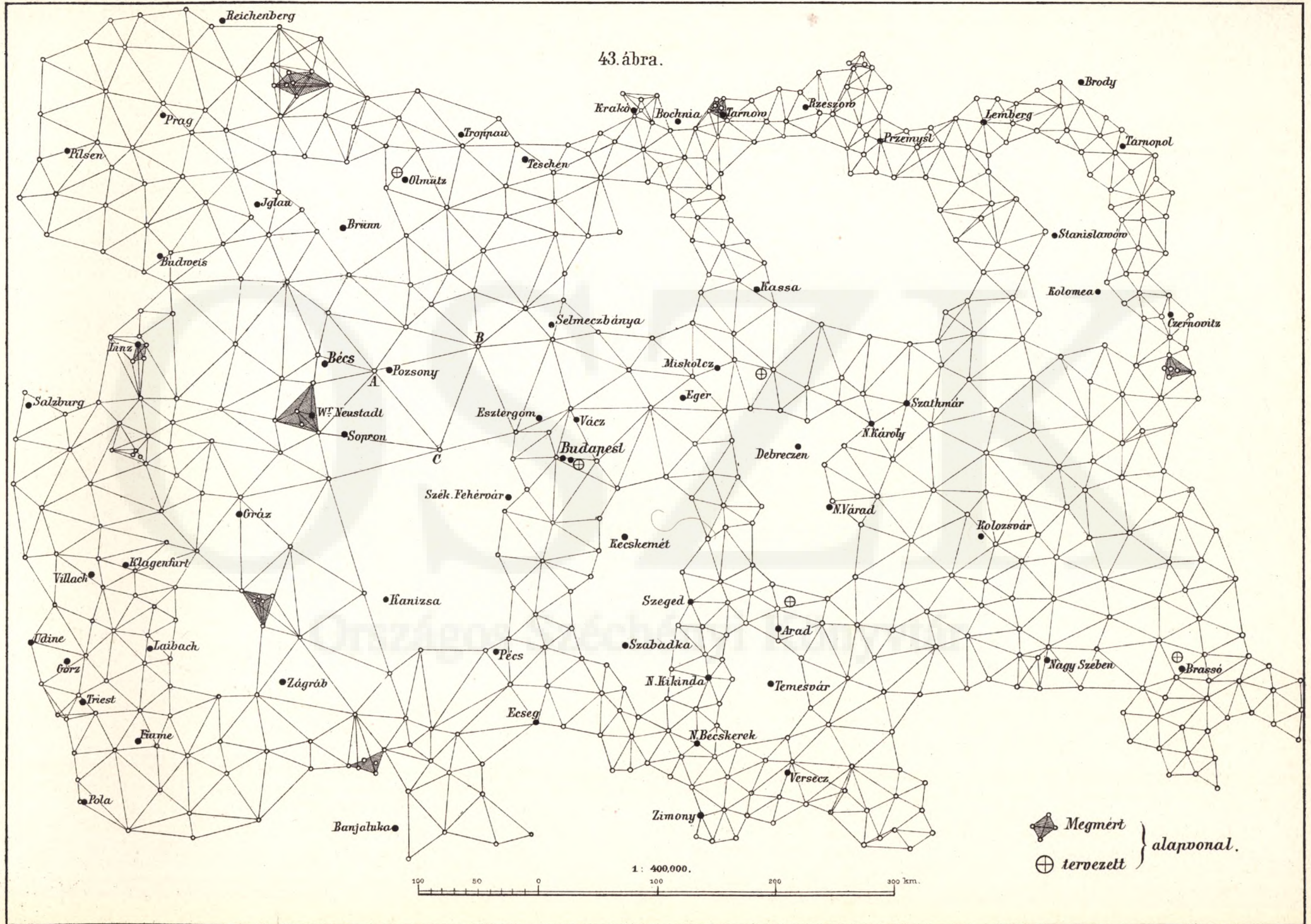

44. ábra.

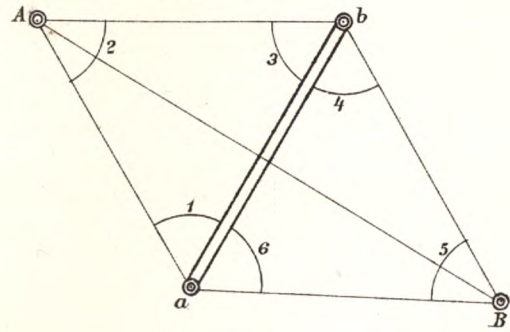

49. ábra.

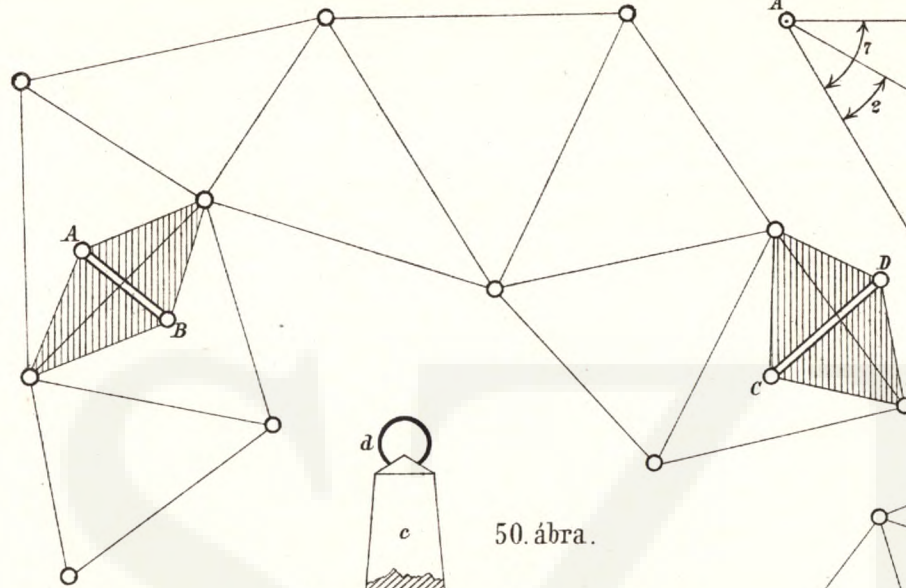

45. ábra.

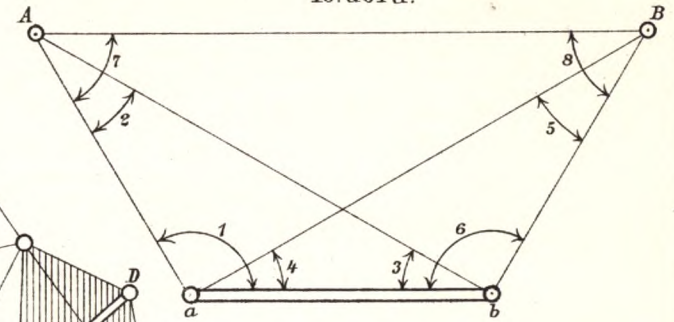

46. ábra.

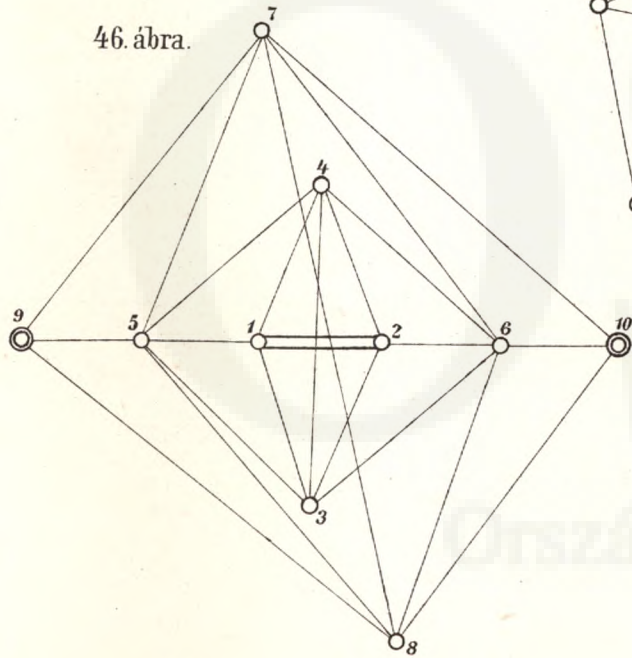

50. ábra.

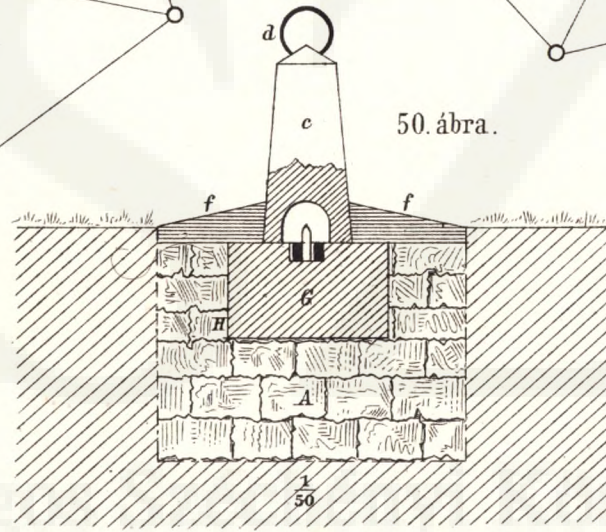

48. ábra.

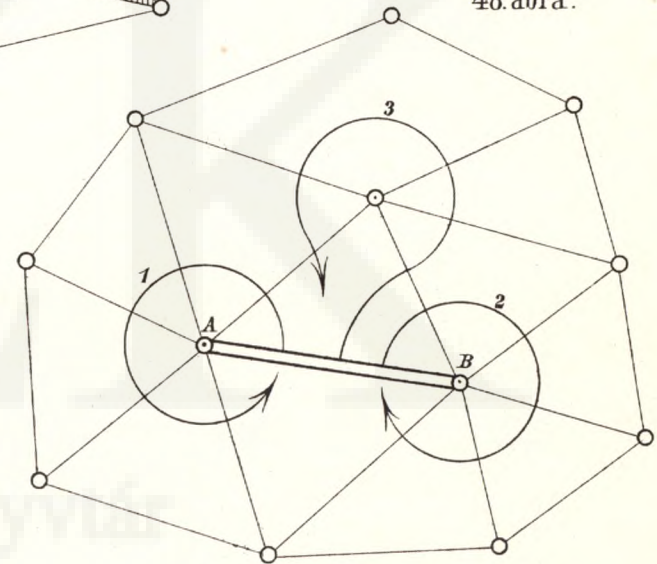

47. ábra.

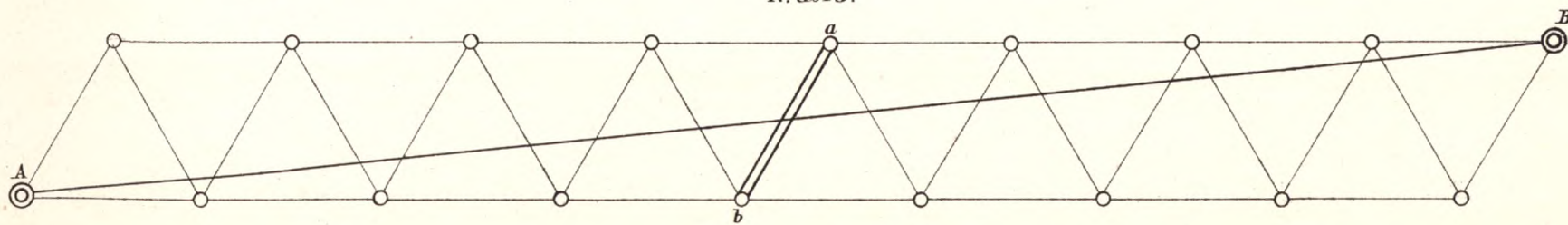

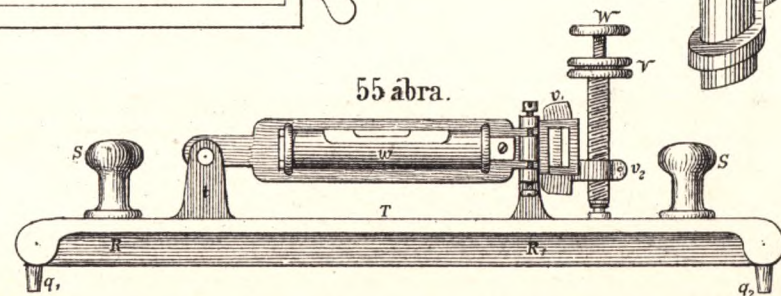
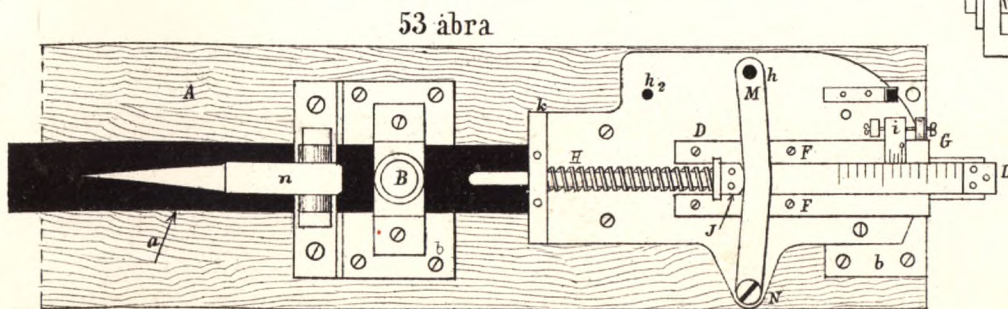
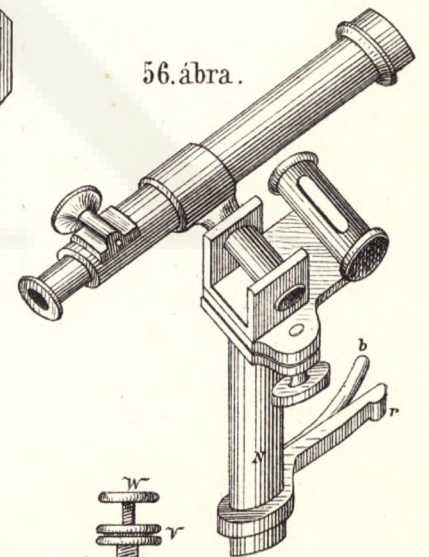
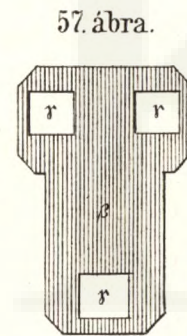
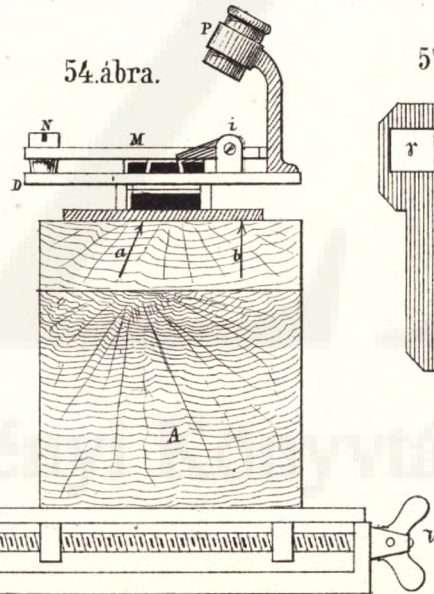
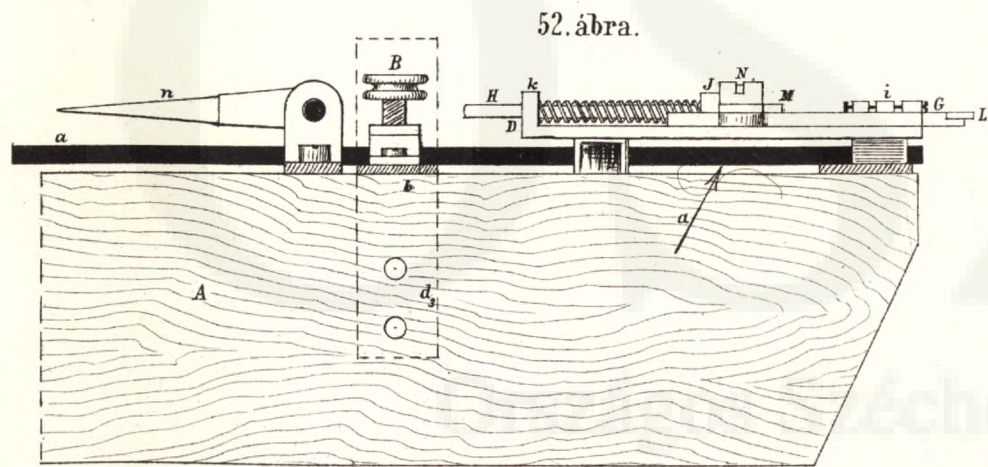
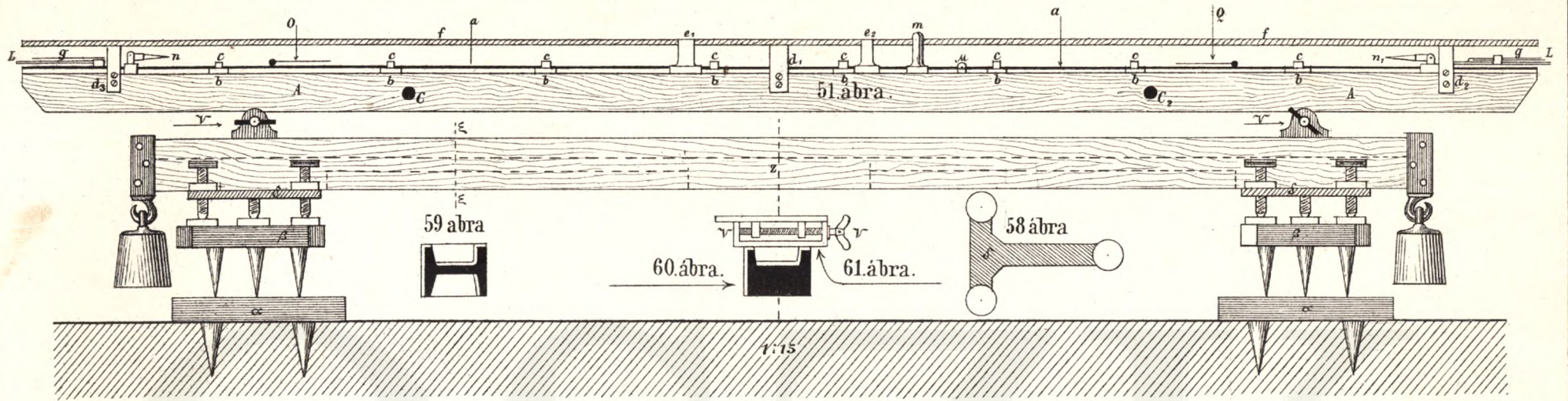

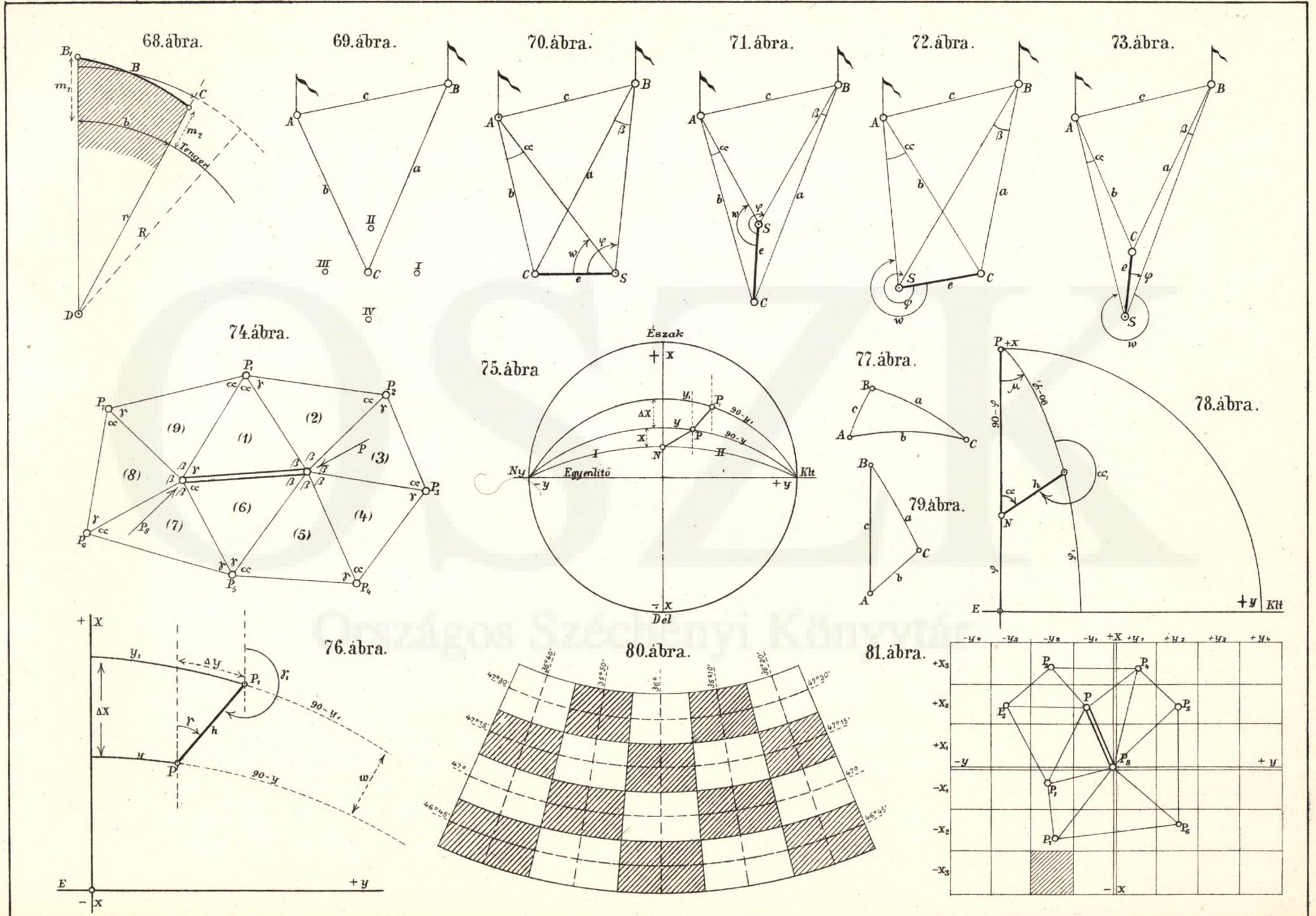

82. ábra.

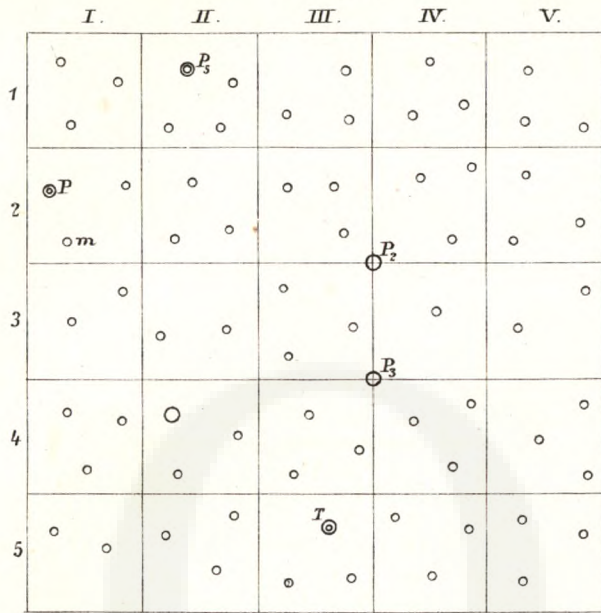

86. ábra.

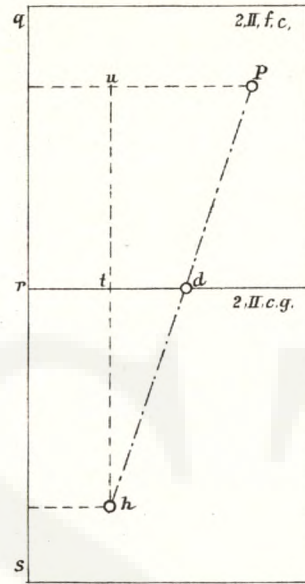

87. ábra.

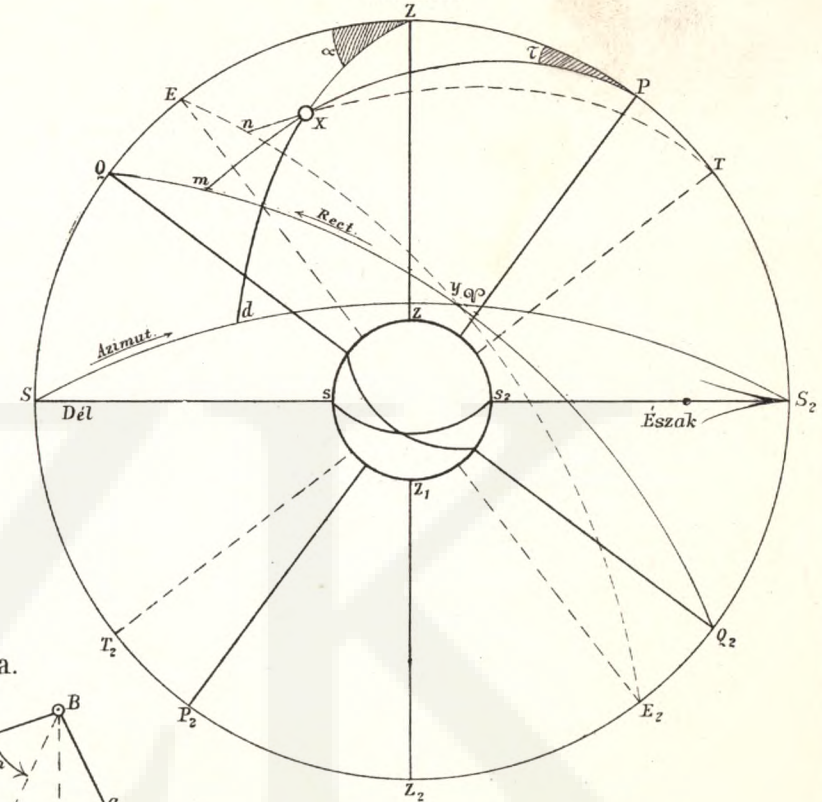

83. ábra.

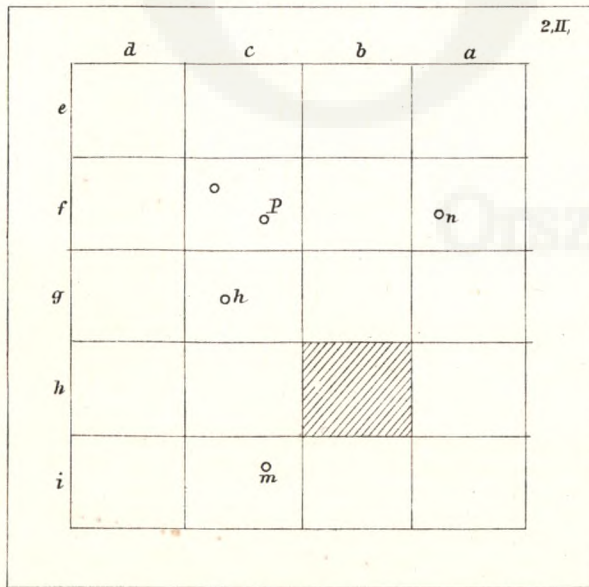

84. ábra.

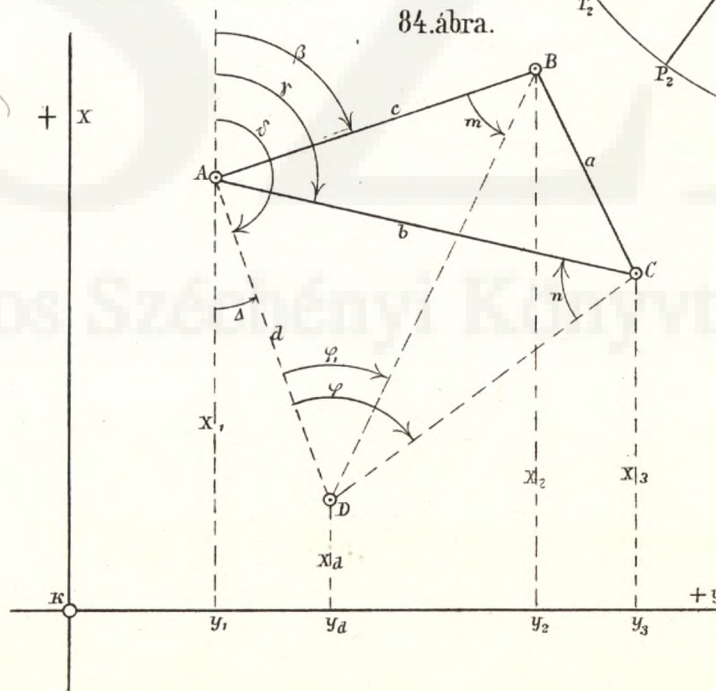

85. ábra.

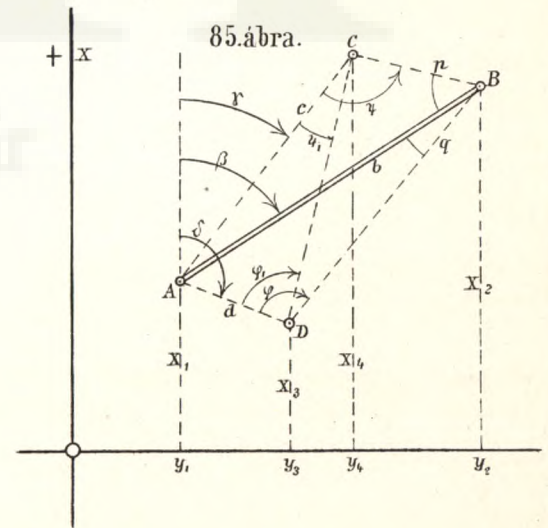

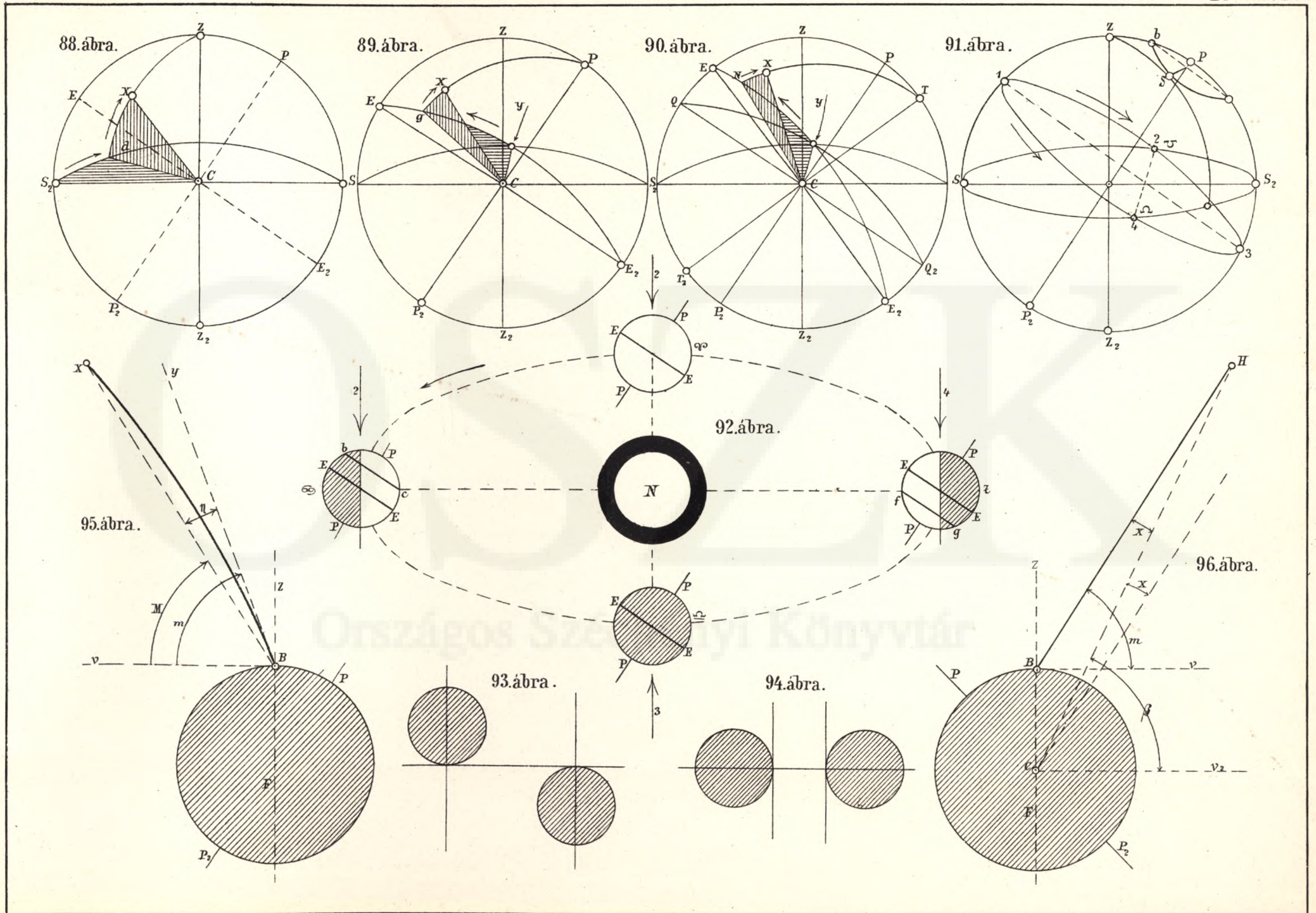

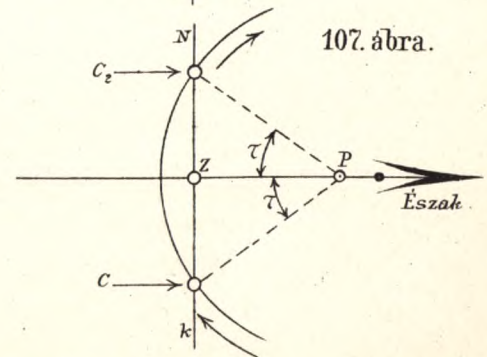
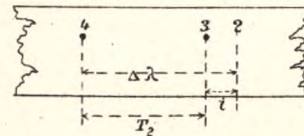
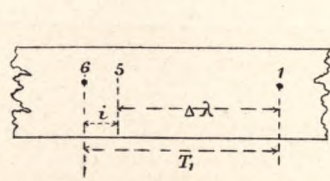
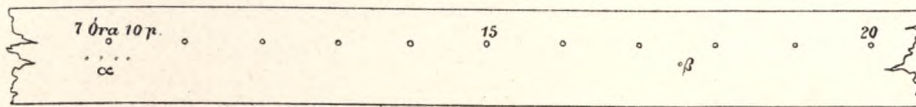
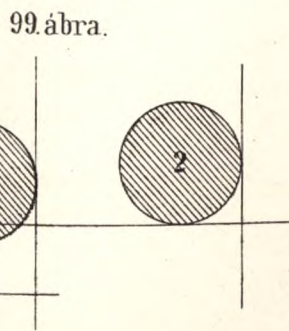
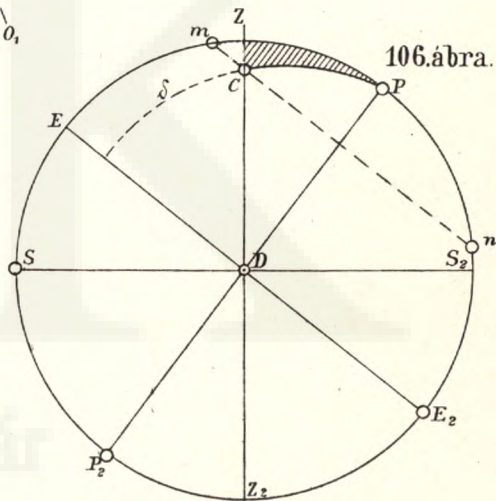
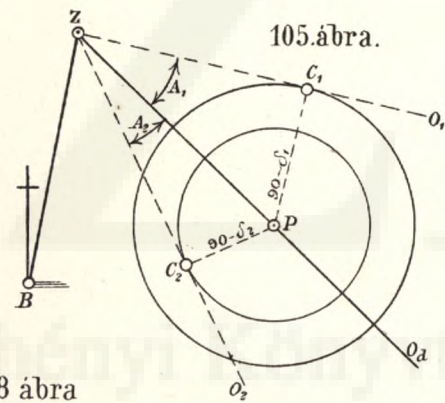
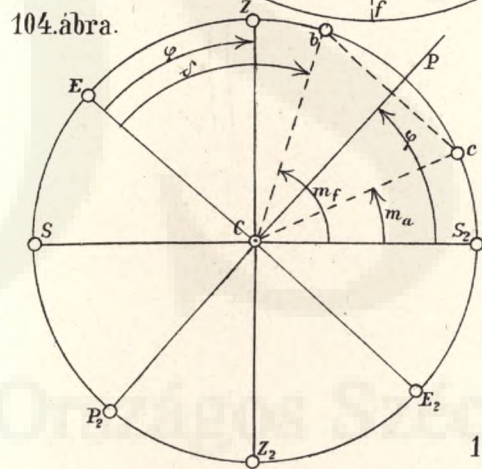
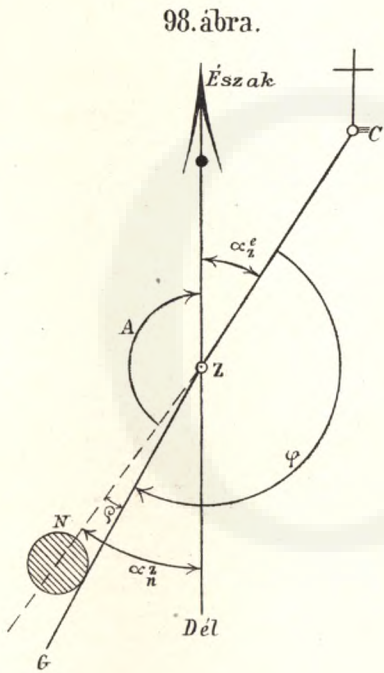
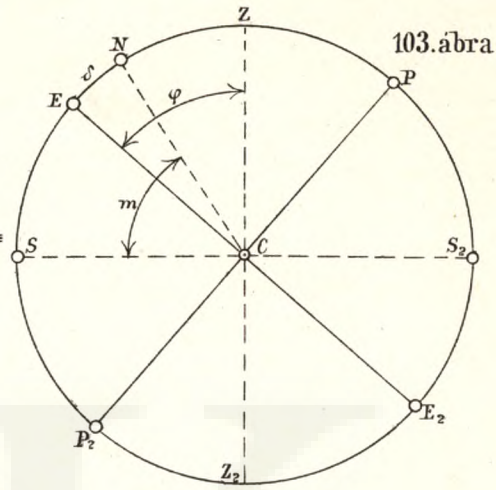
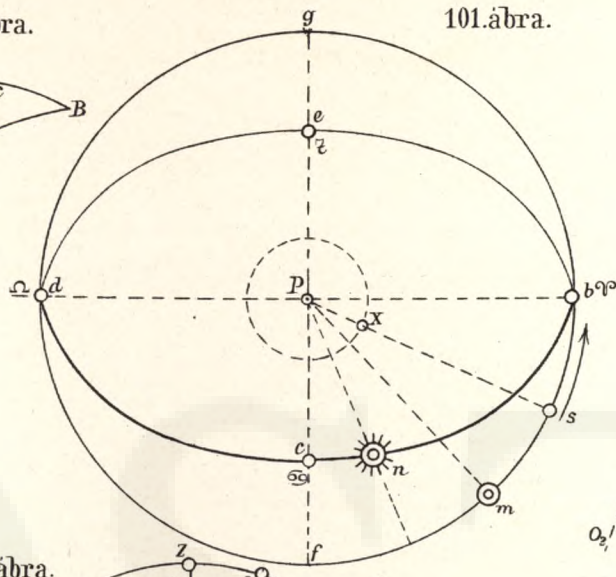
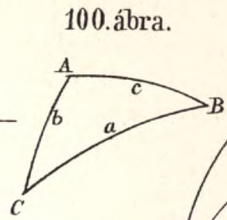
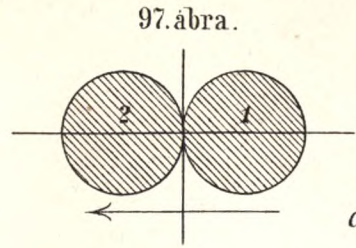

OSZK



Országos Széchényi Könyvtár

OSZK

Országos Széchényi Könyvtár

OSZK

Országos Széchényi Könyvtár

